

Nikon

En

The Nikon Guide to Digital Photography
with the

COOLPIX S5

DIGITAL CAMERA

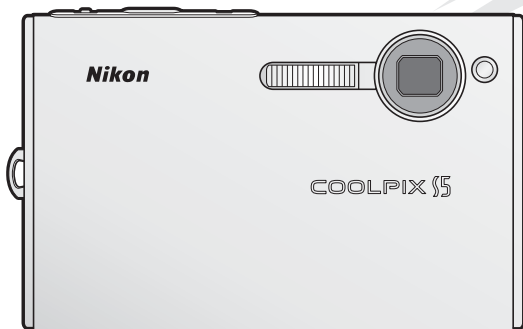

CE

Trademark Information

Macintosh, Mac OS, and QuickTime are registered trademarks of Apple Computer, Inc. Microsoft and Windows are registered trademarks of Microsoft Corporation. The SD logo is a trademark of the SD Card Association. Adobe and Acrobat are registered trademarks of Adobe Systems Inc. ImageLink and the ImageLink print system logo are trademarks of Eastman Kodak Company. Pictmotion is powered by muvee Technologies. PictBridge is a trademark. D-Lighting technology is provided by  Apical Limited. Face-priority AF technology is provided by Identix®. All other trade names mentioned in this manual or the other documentation provided with your Nikon product are trademarks or registered trademarks of their respective holders.

Symbols and Conventions

To make it easier to find the information you need, the following symbols and conventions are used:



This icon marks cautions, information that should be read before use to prevent damage to the camera.



This icon marks notes, information that should be read before using the camera.



This icon marks tips, additional information that may be helpful when using the camera.



This icon indicates that more information is available elsewhere in this manual or in the *Quick Start Guide*.

Memory Cards

Pictures taken with this camera can be stored in the camera's internal memory or on removable memory cards. If a memory card is inserted, all new pictures will be stored on the memory card and delete, playback, and format operations will apply only to the pictures on the memory card. The memory card must be removed before the internal memory can be formatted or used to store, delete, or view pictures.

Introduction

First Steps

Camera Operations

Basic Photography and Playback

Scene and Scene Assist Modes

Movies

Voice Recordings

Viewing Pictures on the Camera

Connecting to Televisions, Computers, and Printers

Menu Guide

Technical Notes

For Your Safety

To prevent damage to your Nikon product or injury to yourself or to others, read the following safety precautions in their entirety before using this equipment. Keep these safety instructions where all those who use the product will read them.

The consequences that could result from failure to observe the precautions listed in this section are indicated by the following symbol:



This icon marks warnings, information that should be read before using this Nikon product to prevent possible injury.

WARNINGS



Turn off in the event of malfunction

Should you notice smoke or an unusual smell coming from the camera or AC adapter, unplug the AC adapter and remove the battery immediately, taking care to avoid burns. Continued operation could result in injury. After removing or disconnecting the power source, take the equipment to a Nikon-authorized service representative for inspection.



Do not disassemble

Touching the internal parts of the camera or AC adapter could result in injury. Repairs should be performed only by qualified technicians. Should the camera or AC adapter break open as the result of a fall or other accident, take the product to a Nikon-authorized service representative for inspection after unplugging the product and/or removing the battery.



Do not use the camera or AC adapter in the presence of flammable gas

Do not use electronic equipment in the presence of flammable gas, as this could result in explosion or fire.



Handle the camera strap with care

Never place the strap around the neck of an infant or child.



Keep out of reach of children

Particular care should be taken to prevent infants from putting the batteries or other small parts into their mouths.



Observe caution when handling batteries

Batteries may leak or explode if improperly handled. Observe the following precautions when handling batteries for use in this product:

- Before replacing the battery, turn the product off. If you are using the AC adapter, be sure it is unplugged.
- Use only rechargeable Nikon EN-EL8 lithium-ion batteries (supplied). Charge the battery either by inserting it in the camera and connecting the supplied AC adapter, or by inserting it in a MH-62 battery charger (available separately).
- When inserting the battery, do not attempt to insert it upside down or backwards.
- Do not short or disassemble batteries.
- Do not expose batteries to flame or to excessive heat.
- Do not immerse in or expose to water.
- Replace the terminal cover when transporting the battery. Do not transport or store with metal objects such as necklaces or hairpins.
- Batteries are prone to leakage when fully discharged. To avoid damage to the product, be sure to remove the battery when no charge remains.
- Discontinue use immediately should you notice any change in the battery, such as discoloration or deformation.
- If liquid from damaged batteries comes in contact with clothing or skin, rinse immediately with plenty of water.

 **Observe the following precautions when handling the AC adapter**

- Use only adapters designated for use with this product.
- Keep dry. Failure to observe this precaution could result in fire or electric shock.
- Dust on or near the metal parts of the plug should be removed with a dry cloth. Continued use could result in fire.
- Do not handle the power cable or go near the adapter during thunderstorms. Failure to observe this precaution could result in electric shock.
- Do not damage, modify, forcibly tug or bend the power cable, place it under heavy objects, or expose it to heat or flame. Should the insulation be damaged and the wires become exposed, take it to a Nikon-authorized service representative for inspection. Failure to observe these precautions could result in fire or electric shock.
- Do not handle the plug or battery charger with wet hands. Failure to observe this precaution could result in electric shock.

 **Use appropriate cables**

When connecting cables to the input and output jacks, use only the cables provided or sold by Nikon for the purpose, to maintain compliance with product regulations.

 **Handle moving parts with care**

Be careful that your fingers or other objects are not pinched by the lens cover or other moving parts.

 **CD-ROMs**

The CD-ROMs supplied with this device should not be played back on audio CD equipment. Playing CD-ROMs on an audio CD player could cause hearing loss or damage the equipment.

 **Observe caution when operating the flash**

Using the flash close to your subject's eyes could cause temporary visual impairment. Particular care should be observed if photographing infants, when the flash should be no less than one meter (39 in.) from the subject.

 **Do not fire the flash while it is touching a person or object**

Such use can result in the person being burned, and/or their clothes igniting from the heat of the flash.

 **Avoid contact with liquid crystal**

Should the monitor break, care should be taken to avoid injury due to broken glass and to prevent liquid crystal from the monitor touching the skin or entering the eyes or mouth.

Notices

- No part of the manuals included with this product may be reproduced, transmitted, transcribed, stored in a retrieval system, or translated into any language in any form, by any means, without Nikon's prior written permission.
- Nikon reserves the right to change the specifications of the hardware and software described in these manuals at any time and without prior notice.
- Nikon will not be held liable for any damages resulting from the use of this product.
- While every effort has been made to ensure that the information in these manuals is accurate and complete, we would appreciate it were you to bring any errors or omissions to the attention of the Nikon representative in your area (address provided separately).

Notice for Customers in the U.S.A.

Federal Communications Commission (FCC) Radio Frequency Interference Statement

This equipment has been tested and found to comply with the limits for a Class B digital device, pursuant to Part 15 of the FCC rules. These limits are designed to provide reasonable protection against harmful interference in a residential installation. This equipment generates, uses, and can radiate radio frequency energy and, if not installed and used in accordance with the instructions, may cause harmful interference to radio communications. However, there is no guarantee that interference will not occur in a particular installation. If this equipment does cause harmful interference to radio or television reception, which can be determined by turning the equipment off and on, the user is encouraged to try to correct the interference by one or more of the following measures:

- Reorient or relocate the receiving antenna.
- Increase the separation between the equipment and receiver.
- Connect the equipment into an outlet on a circuit different from that to which the receiver is connected.
- Consult the dealer or an experienced radio/television technician for help.

Notice for Customers in Canada

CAUTION

This class B digital apparatus meets all requirements of the Canadian Interference Causing Equipment Regulations.

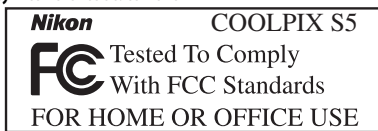

CAUTIONS

Modifications

The FCC requires the user to be notified that any changes or modifications made to this device that are not expressly approved by Nikon Corporation may void the user's authority to operate the equipment.

Interface Cables

Use the interface cables sold or provided by Nikon for your equipment. Using other interface cables may exceed the limits of Class B Part 15 of the FCC rules.

Notice for customers in the State of California

WARNING: Handling the cord on this product will expose you to lead, a chemical known to the State of California to cause birth defects or other reproductive harm. *Wash hands after handling.*

Nikon Inc.,
1300 Walt Whitman Road, Melville, New York
11747-3064, U.S.A. Tel.: 631-547-4200

ATTENTION

Cet appareil numérique de la classe B respecte toutes les exigences du Règlement sur le matériel brouilleur du Canada.

Symbol for Separate Collection in European Countries

This symbol indicates that this product is to be collected separately.



The following apply only to users in European countries:

- This product is designated for separate collection at an appropriate collection point. Do not dispose of as household waste.
- For more information, contact the retailer or the local authorities in charge of waste management.

Notice Concerning Prohibition of Copying or Reproduction

Note that simply being in possession of material that has been digitally copied or reproduced by means of a scanner, digital camera or other device may be punishable by law.

• Items prohibited by law from being copied or reproduced

Do not copy or reproduce paper money, coins, securities, government bonds, or local government bonds, even if such copies or reproductions are stamped "Sample."

The copying or reproduction of paper money, coins, or securities which are circulated in a foreign country is prohibited.

Unless the prior permission of the government has been obtained, the copying or reproduction of unused postage stamps or post cards issued by the government is prohibited.

The copying or reproduction of stamps issued by the government and of certified documents stipulated by law is prohibited.

• Cautions on certain copies and reproductions

The government has issued cautions on copies or reproductions of securities issued by private companies (shares, bills, checks, gift certificates, etc.), commuter passes, or coupon tickets, except when a minimum of necessary copies are to be provided for business use by a company. Also, do not copy or reproduce passports issued by the government, licenses issued by public agencies and private groups, ID cards, and tickets, such as passes and meal coupons.

• Comply with copyright notices

The copying or reproduction of copyrighted creative works such as books, music, paintings, woodcut prints, maps, drawings, movies, and photographs is governed by national and international copyright laws. Do not use this product for the purpose of making illegal copies or to infringe copyright laws.

Disposing of Data Storage Devices

Please note that deleting images or formatting data storage devices such as memory cards or built-in camera memory does not completely erase the original image data. Deleted files can sometimes be recovered from discarded storage devices using commercially available software, potentially resulting in the malicious use of personal image data. Ensuring the privacy of such data is the user's responsibility.

Before discarding a data storage device or transferring ownership to another person, erase all data using commercial deletion software, or format the device and then completely refill it with images containing no private information (for example, pictures of empty sky). Be sure to also replace any pictures selected for the welcome screen. Care should be taken to avoid injury or damage to property when physically destroying data storage devices.

Table of Contents

For Your Safety	ii
Notices	iv
Introduction	1
Parts of the Camera	2
The Monitor	6
The COOL-STATION and AC Adapter	8
First Steps	10
Inserting the Battery	10
Charging the Battery	11
Inserting Memory Cards	12
Camera Operations	14
Turning the Camera on and Off	14
Zoom	15
Focus and Shutter Release	16
Using Menus	17
Basic Photography and Playback	18
 Mode	18
Viewing Pictures	19
Using the Flash	20
Taking Pictures with the Self-Timer	22
Macro Close-up Mode	23
One-Touch Portrait Mode	24
Scene and Scene Assist Modes	26
Scene Mode	26
Scene Assist Mode	32
Movies	35
Recording Movies	35
The Movie Menu	36
Movie Playback	37
Voice Recordings	38
Viewing Pictures on the Camera	41
Viewing Multiple Pictures: Thumbnail Playback	41
Deleting Pictures	41
Taking a Closer Look: Playback Zoom	42
Enhancing Contrast: D-Lighting	43
Voice Memos: Recording and Playback	44
Viewing Pictures by Date	45
Pictmotion by muvee	48
Connecting to Televisions, Computers, and Printers	52
Viewing Pictures on TV	52

Viewing Pictures on a Computer	52
Printing Pictures	55
Menu Guide	61
Shooting Options: The Shooting Menu	61
Image Mode	61
White Balance	62
Exp. +/-	63
Continuous	63
Best Shot Selector (BSS)	65
Sensitivity	65
Color Options	66
AF Area Mode	66
Playback Options: The Playback Menu	67
Print Set	67
Slide Show	68
Delete	68
Protect	68
Transfer Marking	68
Small Pic.	69
Copy	69
Basic Camera Setup: The Setup Menu	70
Menus	70
Quick Startup	70
Welcome Screen	71
Date	71
Monitor Settings	73
Date Imprint	74
AF Assist	75
Sound Settings	75
Blur Warning	75
Auto Off	75
Format Memory/ Format Card	76
Language	76
Interface	76
Reset all	76
Firmware Version	76
Technical Notes	77
Optional Accessories	77
Caring for the Camera	78
Error Messages	80
Troubleshooting	83
Appendix	86
Specifications	91
Index	94

Use Only Nikon Brand Electronic Accessories

Nikon COOLPIX cameras are designed to the highest standards and include complex electronic circuitry. Only Nikon brand electronic accessories (including battery chargers, batteries, and AC adapters) certified by Nikon specifically for use with this Nikon digital camera are engineered and proven to operate within the operational and safety requirements of this electronic circuitry.

THE USE OF NON-NIKON ELECTRONIC ACCESSORIES COULD DAMAGE THE CAMERA AND MAY VOID YOUR NIKON WARRANTY.

For more information about Nikon brand accessories, contact a local authorized Nikon dealer.

***Holographic seal:** Identifies this device as an authentic Nikon product.



EN-EL8
rechargeable
battery

Introduction

Thank you for your purchase of a Nikon COOLPIX S5 digital camera. This manual has been written to help you enjoy taking pictures with your Nikon digital camera. Please be sure to read all instructions thoroughly to get the most from the camera, and keep them where they will be read by all those who use the product.

Before Taking Important Pictures

Before taking pictures on important occasions (such as at weddings or before taking the camera on a trip), take a test shot to ensure that the camera is functioning normally. Nikon will not be held liable for damages or lost profits that may result from product malfunction.

Life-Long Learning

As part of Nikon's "Life-Long Learning" commitment to ongoing product support and education, continually-updated information is available on-line at the following sites:

- For users in the U.S.A.: <http://www.nikonusa.com/>
- For users in Europe and Africa: <http://www.europe-nikon.com/support>
- For users in Asia, Oceania, and the Middle East: <http://www.nikon-asia.com/>

Visit these sites to keep up-to-date with the latest product information, tips, answers to frequently-asked questions (FAQs), and general advice on digital imaging and photography. Additional information may be available from the Nikon representative in your area. See the URL below for contact information:

<http://nikonimaging.com/>

Parts of the Camera

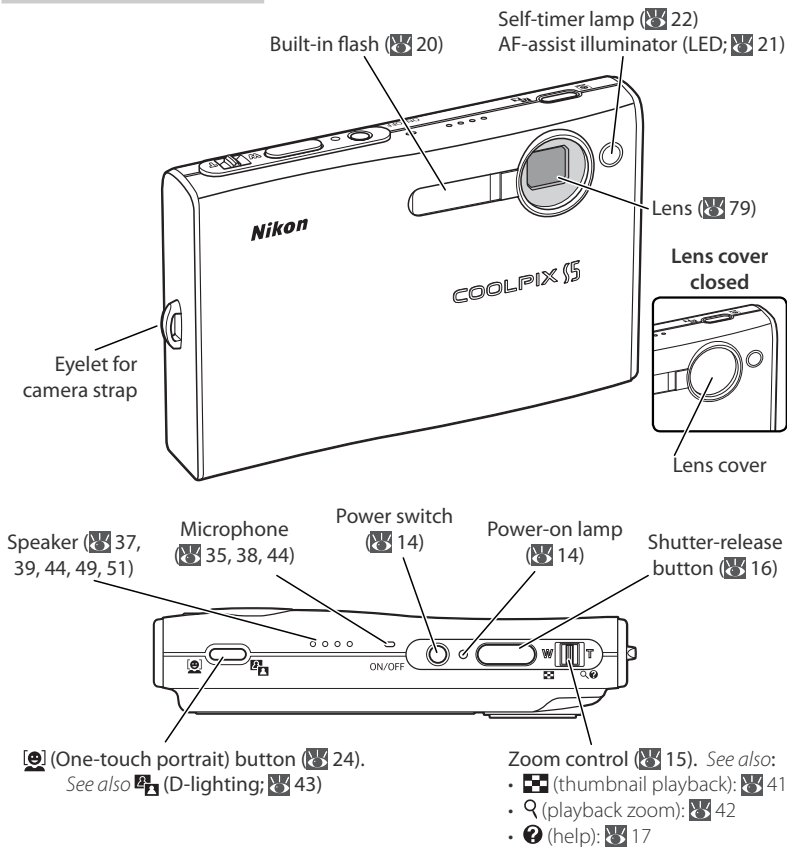

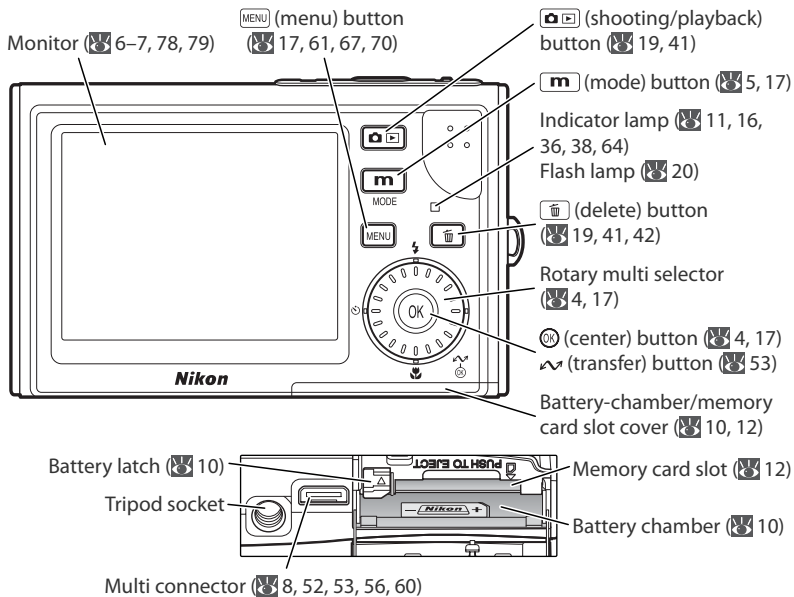

Attaching the Camera Strap

Attach the strap as shown at right.

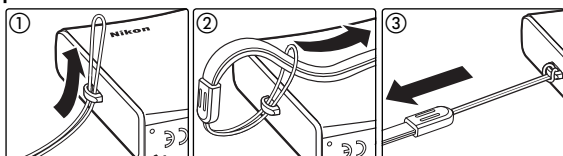

The Rotary Multi Selector

The rotary multi selector is used to navigate the camera menus. Rotate in either direction to highlight items and press the center (OK) to select. To cancel and return to the previous menu, press the rotary multi selector to the left.



Rotate: highlight



Press center (OK): select

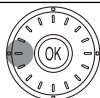

Press left: cancel

Items can also be highlighted by pressing the rotary multi selector up, down, left, or right.



Press up or down



Press right

Menu Help

For help on the current menu or menu item, press the zoom control to **T** (Z, 17).

The **m** (Mode) Button

Pressing the **m** button during shooting or playback displays a mode-selection menu (17).

Shooting Modes

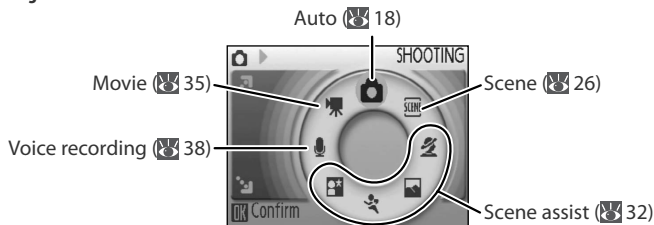

Playback Modes

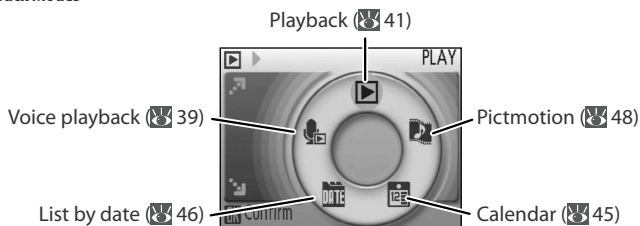

The Monitor

The following indicators may appear in the monitor during shooting and playback (actual display varies with current camera settings):

Shooting

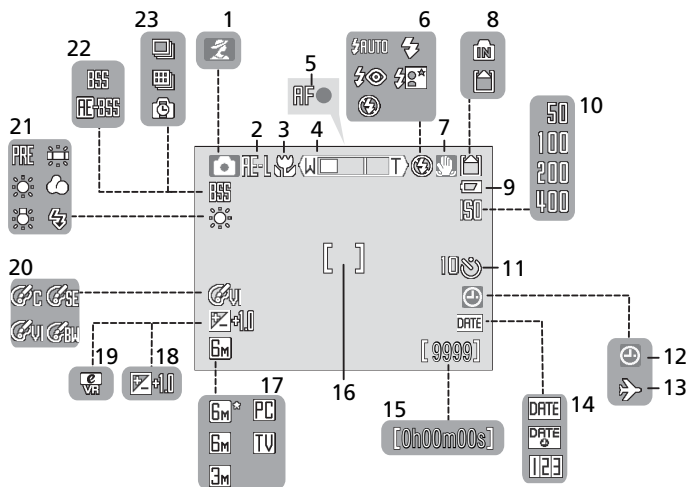

Playback

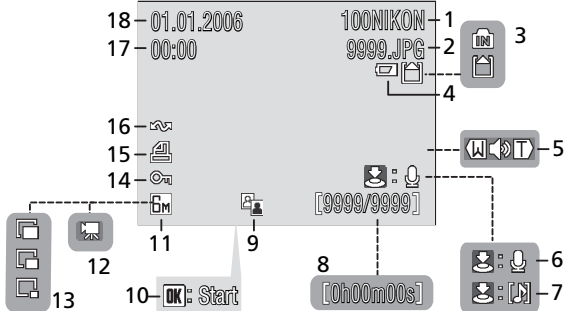

1	Shooting mode.....	5, 18, 26, 35
2	Exposure lock.....	29
3	Macro close-up mode.....	23, 28
4	Zoom indicator.....	15, 23
5	Focus indicator.....	16
6	Flash mode.....	20
7	Camera shake icon.....	21
8	Internal memory/memory card indicator.....	14
9	Battery level indicator.....	14
10	Sensitivity.....	21, 65
11	Self-timer indicator/count down.....	22
12	"Date not set" indicator.....	80
13	Time zone indicator.....	71
14	Date imprint/date counter.....	74
15	Number of exposures remaining.....	14, 88
	Movie length.....	35, 88
16	Focus areas.....	16, 66
17	Image mode.....	61
18	Exposure compensation.....	25, 31, 63
19	Electronic VR indicator.....	37
20	Color option.....	66
21	White balance.....	62
22	Best Shot Selector (BSS).....	65
23	Continuous shooting mode.....	63

1	Current folder*.....	89
2	File number and type*.....	89
3	Internal memory/memory card indicator.....	14
4	Battery level indicator.....	14
5	Volume indicator.....	37, 39, 44
6	Voice memo recording guide.....	44
7	Voice memo playback guide.....	44
8	Current frame number/ total number of frames Movie length.....	37
9	D-Lighting icon.....	43
10	Movie playback indicator.....	37
11	Image mode.....	61
12	Movie indicator.....	37
13	Small picture indicator.....	69
14	Protect icon.....	68
15	Print icon.....	59
16	Transfer icon.....	53, 68, 76
17	Time of recording*.....	71
18	Date of recording*.....	71

* Display differs in calendar and list-by-date modes (47).

The COOL-STATION and AC Adapter

The COOL-STATION

The supplied MV-14 COOL-STATION can be used to:

- Charge the camera battery (🔌 11)
- Copy pictures to a computer (🔌 52)
- View pictures on a television (🔌 52)
- Print pictures via direct USB connection (🔌 55)



Camera connector

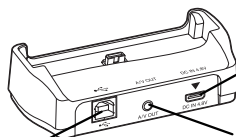

USB connector
(🔌 53, 56)

DC-IN connector
(🔌 9)

Audio/video connector
(A/V out; 🔌 52)

Placing the Camera in the COOL-STATION

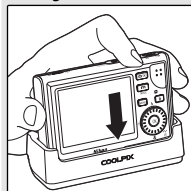

The multi connector should be fully inserted in the COOL-STATION camera connector as shown.

Removing the Camera

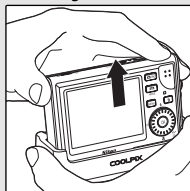

Remove the camera as shown.

The AC Adapter

The supplied EH-64 AC adapter can charge the battery in the camera (🔌 11) or power the camera for playback, data transfer, or printing (**do not use any other make or model of AC adapter**; failure to observe this precaution could result in fire or product malfunction). Connect the power cord (①) and plug the adapter into the COOL-STATION or camera (②), making sure the plugs are in the correct orientation. Plug the adapter in (③) and check that the power lamp is lit (④).

COOL-STATION

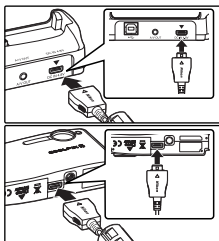

Camera

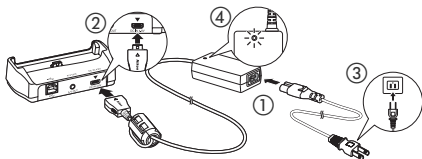

First Steps

Inserting the Battery

The camera uses a rechargeable EN-EL8 Li-ion battery (supplied).

- 1** Turn the camera off
If the power-on lamp is lit, press the power switch to turn the camera off.

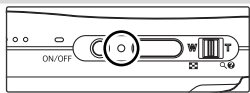

- 2** Open the battery-chamber/memory card slot cover



- 3** Insert the battery
The orange battery latch is pushed aside as the battery is inserted. The battery is fully inserted when the latch clicks back into place.

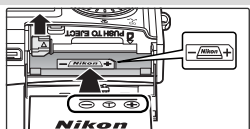

✓ Inserting the Battery

Inserting the battery upside down or backwards could damage the camera. Check to be sure the battery is in the correct orientation.

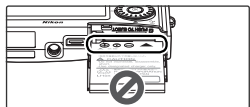

- 4** Close the battery-chamber/memory card slot cover

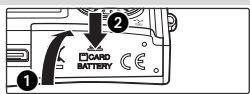

✓ Batteries

Read and follow the warnings and cautions on pages ii–iii and 79 of this manual.

✂ Removing the Battery

Turn the camera off before removing or inserting batteries. To eject the battery, open the battery-chamber/memory card slot cover and slide the battery latch in the direction shown. The battery can then be removed by hand. Note that the battery may become hot during use; observe due caution when removing the battery.

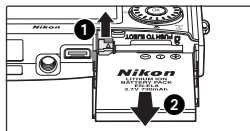

Charging the Battery

Charge the battery before first use or when the battery is running low.

1 Turn the camera off

If the power-on lamp is lit, press the power switch to turn the camera off.

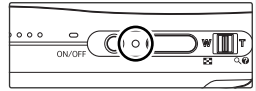

2 Connect the AC adapter

Connect the AC adapter directly to the camera or place the camera in the COOL-STATION and connect the AC adapter (89).

3 Charge the battery

The indicator lamp next to the camera monitor will blink green as the battery charges. (If the lamp flickers rapidly, the camera is not correctly inserted or the battery is faulty. Reinsert the camera or replace the battery.)

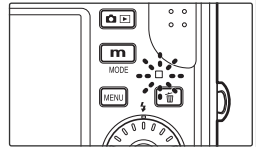

Charging is complete when the indicator lamp stops blinking (a fully exhausted battery will recharge in about two hours). Remove the camera from the COOL-STATION and unplug the AC adapter.

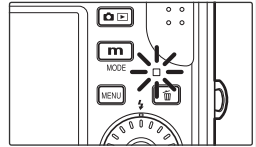

The MH-62 Battery Charger

The battery can also be charged using the optional MH-62 battery charger (877).

Inserting Memory Cards

Pictures are stored in the camera's internal memory (approximately 21 MB) or on removable Secure Digital (SD) memory cards (📷 77). Internal memory is used for recording and deleting pictures only if no memory card is inserted.

To insert a memory card:

1 Turn the camera off

If the power-on lamp is lit, press the power switch to turn the camera off.

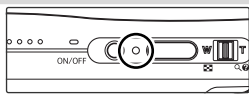

2 Insert the memory card

Open the battery-chamber/memory card slot cover and slide the memory card in until it clicks into place. Close the memory card slot cover.

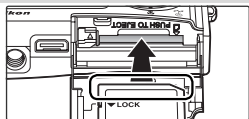

✓ Inserting Memory Cards

Check to be sure the card is in the correct orientation. Inserting the card upside down or backwards could damage the camera or the card.

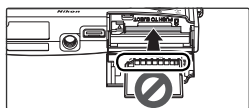

3 Press the power switch to turn the camera on

If no message is displayed in the monitor, the camera is ready for use.

If the message shown at right is displayed, the memory card must be formatted before use. Note that **formatting permanently deletes all pictures** and other data on the memory card. Be sure to make copies of any pictures you wish to keep before beginning formatting.

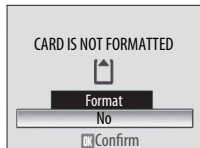
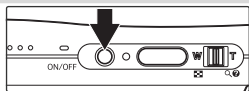

To begin formatting, rotate the rotary multi selector to highlight **Format** and then press the **OK** button. **Do not turn the camera off or remove the batteries or memory card until formatting is complete.**

Removing Memory Cards

Before removing memory cards, *turn the camera off* and confirm that the power-on and indicator lamps are off. Open the battery-chamber/memory card slot cover and press the card in to partially eject the card. The card can then be removed by hand.

The Write Protect Switch

SD cards are equipped with a write protect switch. Pictures can not be recorded or deleted and the memory card can not be formatted when this switch is in the "lock" position.

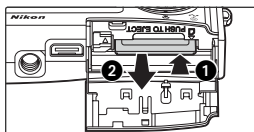

Write protect switch

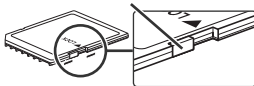

Camera Operations

Turning the Camera on and Off

To turn the camera on, press the power switch. The power-on lamp will light...

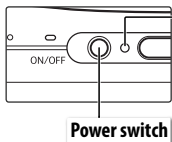

Power-on lamp

On	Camera on.
Blinks	Monitor has turned off to save power (see below).
Flickers	Battery exhausted. Recharge or change battery.
Off	Camera off.

...and the monitor will turn on.

Battery indicator

NO ICON	Battery fully charged.
	Low battery; prepare to recharge or change battery.
WARNING!! BATTERY EXHAUSTED	Battery exhausted. Recharge or change battery.

Shooting mode

5, 18, 26, 32, 35)

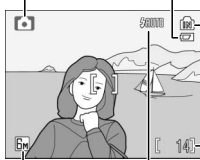

Internal memory/memory card indicator 12)

	Pictures will be recorded to internal memory.
	Pictures will be recorded to memory card.

Number of exposures remaining 88)

Image mode 61)

Flash mode 20)

To turn the camera off, press the power switch and wait for the power-on lamp to turn off.

Turning the Camera on (Playback Mode)

If the button is pressed for about a second when the camera is off, the camera will turn on in playback mode 41).

Auto Power off (Stand-by Mode)

In shooting mode, the monitor will dim to reduce the drain on the battery if no operations are performed for about five seconds. The monitor will brighten when camera controls are used. At default settings, the monitor will turn off altogether if no operations are performed for about a minute during shooting and playback (stand-by mode; 75). The camera will turn off automatically if no operations are performed for another three minutes.

Zoom

The zoom control is used to frame subjects in the monitor. Select **W** to zoom out, increasing the area visible in the frame. Select **T** to zoom in up to 3× so that the subject fills a larger area of the frame. The amount of zoom is displayed in the monitor.

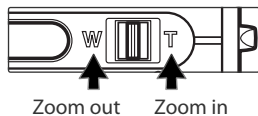

Indicator is displayed when zoom control is pressed

Optical zoom (up to 3×)

Indicator turns yellow when digital zoom is in effect

Holding the control to **T** for about two seconds at 3× zoom will trigger digital zoom, allowing the subject to be magnified up to 4× more, for a total of magnification of 12×.

Digital Zoom

Unlike optical zoom, digital zoom does not increase the amount of detail visible in the picture. Instead, details visible at 3× zoom are simply enlarged, producing a slightly “grainy” image.

Focus and Shutter Release

The camera features a two-stage shutter-release button. First, lightly press the shutter-release button about halfway, stopping when you feel resistance. Once the camera has focused, press the shutter-release button the rest of the way down to release the shutter and take a picture.

- 1 Focus:** Press the shutter-release button halfway. If the camera is able to focus on the subject in the focus area at the center of the frame, the focus (AF●) indicator and focus area will be displayed in green. If they blink red, the camera was unable to focus. Change the composition and try again.

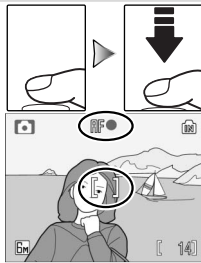

- 2 Shoot:** Gently press the shutter release button the rest of the way down (moving the camera when releasing the shutter may result in blurred pictures). The flash may fire if the subject is poorly lit.



✓ During Recording

While pictures are being recorded, the  or  icon will blink and the indicator lamp will blink green. Removing memory cards or batteries while these indicators are blinking or the  (wait) icon is displayed could affect pictures or damage the camera or card.

Using Menus

To make a selection from the shooting or playback menus, press the **[MENU]** button and follow the steps below:

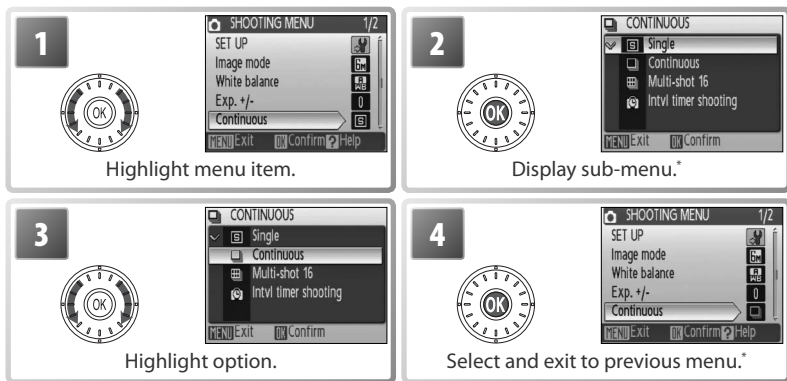

* In some cases, menu items can also be selected by pressing rotary multi selector to right.

To make a selection from the shooting or playback mode menus, press the **[m]** button and follow the steps below:

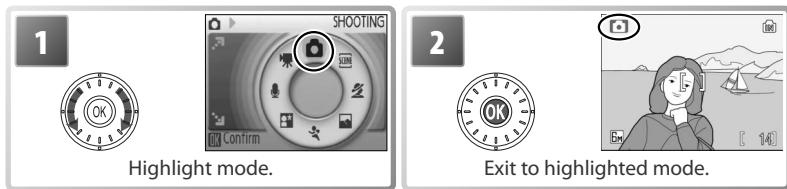

Lost?

For help on the current menu, press the zoom control to **T** (🔍). Press the **[OK]** button to display the options for the selected item. To return to the original menu, press the zoom control to **T** (🔍), or press the **[MENU]** button to return to shooting or playback.

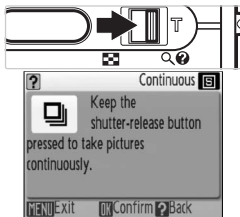



Basic Photography and Playback

Mode

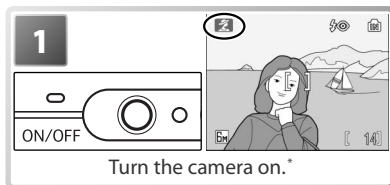
This section describes how to take pictures in  (auto) mode, an automatic, “point-and-shoot” mode recommended for first-time users of digital cameras.



* If  is displayed in monitor, camera is already in  mode. Proceed to Step 5.

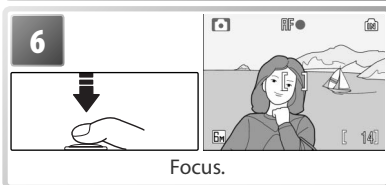
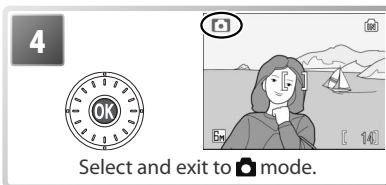
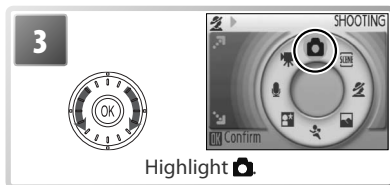

Take picture. If lighting is poor, AF-assist illuminator may light when camera focuses and flash may fire when picture is taken ( 20, 21).

Holding the Camera

Hold the camera steadily in both hands, keeping your fingers and other objects away from the lens, flash, self-timer lamp, and microphone.

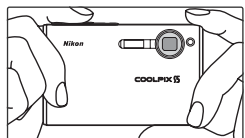

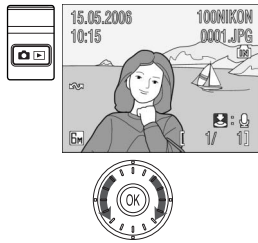

Viewing Pictures

Press the  button to display a picture in the monitor (if the picture was taken with the camera rotated 90°, it will be displayed in “tall” orientation). Use the rotary multi selector to view additional pictures: rotate the rotary multi selector clockwise to view pictures in the order recorded, counter-clockwise to view pictures in reverse order. Rotate quickly to scroll rapidly to the desired picture. Pictures may be displayed briefly at low resolution while being read from memory.



Press the  button again to return to shooting mode.



Deleting Unwanted Pictures

To delete the picture currently displayed in the monitor, press the  button. A confirmation dialog will be displayed; highlight one of the following options and press the  button:

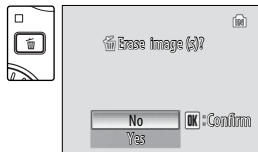
- **No:** Exit without deleting the picture.
- **Yes:** Delete the picture.



Deleting the Last Shot





To delete the most recent picture, press the  button while the camera is in shooting mode. A confirmation dialog will be displayed; highlight **Yes** and press  to delete the last shot taken.

The Rotary Multi Selector

As an alternative to rotating the rotary multi selector, press the rotary multi selector down or right to view pictures in the order recorded, up or left to view pictures in reverse order. Keep pressed to scroll rapidly to the desired picture.

Using the Flash

The flash has a range of 0.3–2.6 m (1 ft.–8 ft. 6 in.) when the camera is zoomed all the way out. The range at maximum zoom is 0.3–1.4 m (1 ft.–4 ft. 7 in.). The following flash modes are available:

Mode	Description
 Auto	Flash fires automatically when lighting is poor.
 Auto with red-eye reduction	Reduces “red eye” in portraits (see following page).
 Flash Cancel (off)	Flash will not fire even when lighting is poor.
 Anytime Flash (fill flash)	Flash fires whenever picture is taken. Use to “fill-in” (illuminate) shadows and back-lit subjects.
 Slow sync	Flash illuminates main subject; slow shutter speeds are used to capture background at night or under dim light.

1



Display flash-mode menu.

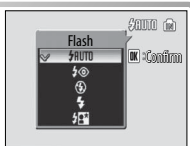

2



Highlight mode.

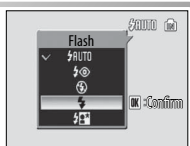

3



Make selection (to exit without changing mode, wait five seconds). Selection is shown by icon in display. Selection for  mode is stored in memory even when camera is off.

The Flash Lamp

The flash lamp shows flash status when the shutter-release button is pressed halfway.

- **On (red):** Flash will fire when picture is taken
- **Blinks red:** Flash charging. Wait a few seconds and try again.
- **Off:** Flash off or not required.

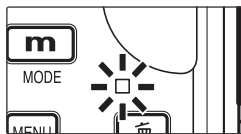

Red-eye Reduction

The camera uses *advanced red-eye reduction*. Low-intensity light pulses cause the subject's pupils to contract before the flash fires. If the camera still detects red-eye, it will process the image to further its effects ("In-Camera Red-eye Fix"; note that this may slightly increase the time needed to record the picture). This mode is not recommended where a quick shutter response is required; if the desired results are not achieved, try again at a different flash setting.

When Lighting Is Poor

① The AF-assist illuminator may light

If lighting is poor, the AF-assist illuminator may light to assist the focus operation when the shutter-release button is pressed halfway. The illuminator has a maximum range of about 1.9 m/6 ft. 3 in. (W) to 1.1 m/3 ft. 7 in. (T). The AF-assist illuminator is not available in some modes (📷 84) and can also be turned off manually (📷 75), although in this case the camera may not focus when lighting is poor.



② A blur warning may be displayed

If the flash is off, a 📷 icon will be displayed to warn that pictures may be blurred as a result of slow shutter speeds. If an **ISO** icon is displayed, sensitivity has been raised to compensate for poor lighting and pictures may be affected by "noise" in the form of randomly-spaced, brightly-colored dots (📷 65). The camera may process pictures to reduce noise, doubling recording times.

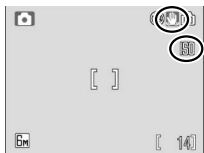

If the warning at right is displayed after a picture is taken, the picture may be blurred. Select **No** to exit without recording the picture. If no operations are performed for about twenty seconds, the picture will be recorded automatically.



Taking Pictures with the Self-Timer

The camera is equipped with a ten- and three-second timers for self-portraits and to reduce blur. When using the self-timer, mount the camera on a tripod (recommended) or rest it on a flat, level surface.

1



Display self-timer menu.

2



Highlight option.

3s: Use to reduce blur.

10s: Use for self-portraits.

3



Make selection (to exit without setting timer, wait five seconds).  icon appears in display.

4



Frame picture and start timer; display in monitor shows seconds remaining before shutter is released. To stop timer before picture is taken, press shutter-release button again.

The self-timer lamp will blink until one second before the picture is taken, staying lit during the final second to warn that the shutter is about to be released.

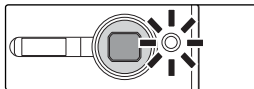

Macro Close-up Mode

Macro close-up mode is used for taking shots of objects as close as 4 cm (1.6 in.).

- 

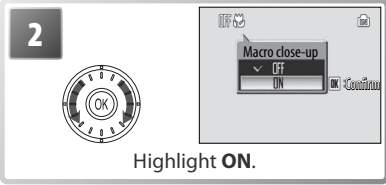
1 Display macro close-up menu.
- 

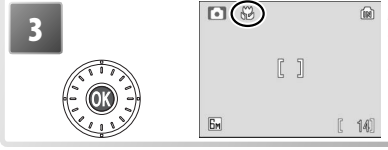
2 Highlight ON.
- 

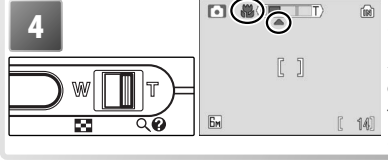
3 Make selection (to exit without changing mode, wait five seconds). Selection is shown by icon in display.
- 

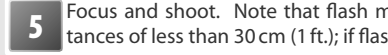

4 Frame picture. Minimum focus distance varies with zoom position; if zoom is adjusted to ▲ position and icon turns green, camera can focus at distance of 4 cm (1.6 in.). Camera focuses continuously until shutter-release button is pressed halfway to lock focus.
- 

5 Focus and shoot. Note that flash may be unable to light entire subject at distances of less than 30 cm (1 ft.); if flash fires, play picture back and check results.

The macro close-up mode option last selected for  (auto) mode is restored the next time  mode is selected.

One-Touch Portrait Mode

For portrait shots, press the  button when the camera is in shooting mode. This will automatically activate the following features:

- **Portrait:** Background details are softened, allowing the portrait subject to stand out clearly.
 - **Face-priority AF:** The camera automatically detects and focuses on faces.
 - **Advanced red-eye reduction:** Reduces “red-eye” caused by the flash ( 21).
- Macro close-up is not available in one touch portrait mode. To return to the previously selected shooting mode, press the  button again.

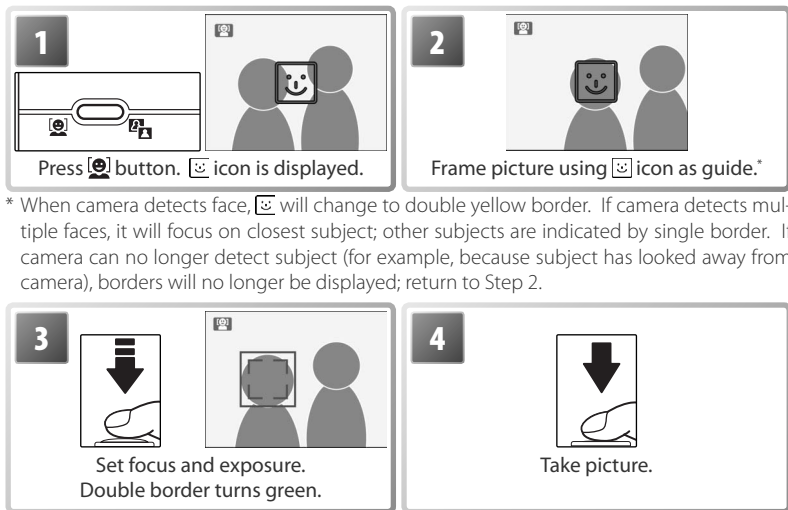







Face-Priority AF

The camera's ability to detect faces depends on a variety of factors, including whether or not the subject is facing the camera. The camera may be unable to detect faces that are hidden by sunglasses or other obstructions or that take up too much or too little of the frame. If no face is detected when the shutter-release button is pressed halfway, the camera will focus on the center of the frame.

The camera will focus continuously until a face detected. If the double border flashes yellow when the shutter-release button is pressed halfway, the camera is unable to focus; release the button and try again.

The One-Touch Portrait Menu

Pressing the  button in one-touch portrait mode displays the one-touch portrait menu. With the exception of exposure compensation, the options chosen in this menu are restored the next time one-touch portrait mode is selected.

Option	Description
 SET UP	Display setup menu ( 70)
 Image mode	Choose image size and quality ( 61).
 Exp. +/-	Alter exposure from the value selected by the camera. Choose from values between -2.0 EV and +2.0 EV. Negative values produce darker pictures, positive values brighter pictures.
 Portrait effect	Choose from Normal , Brighter (reduces vividness of skin tones), and Softer (soft effect).

Scene and Scene Assist Modes

The camera offers a choice of eleven “scene” and four “assist” options. Camera settings are automatically optimized for the selected subject type.

Scene mode: The following scenes are available.

Party/Indoor	Night Landscape	Copy
Beach/Snow	Close Up	Back Light
Sunset	Museum	Panorama Assist
Dusk/Dawn	Fireworks Show	

Scene assist modes: These scenes offer framing assist to help compose shots.

Mode	Description	Mode	Description
Portrait	For portraits.	Sports	For moving subjects.
Landscape	For landscapes.	Night Portrait	For portraits taken against a night backdrop.

Scene Mode

To take pictures in scene mode, select shooting mode and follow these steps:

1 SHOOTING
Display shooting mode menu.

2 SCENE
Highlight **SCENE**.

3 []
Select and exit to last selected scene.

4 PARTY/INDOOR
Display scene menu.

5 BEACH/SNOW
Highlight scene.*

6 []
Select and exit to selected scene.

* Select to display setup menu (70), to display image-mode menu (61), to adjust exposure compensation (31).

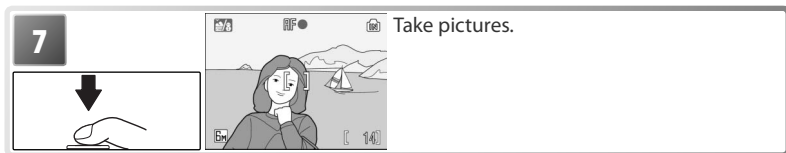

The following scenes are available:

<p>Party/Indoor</p> <p>Use for shots that include details of the background, or to capture the effects of candlelight and other indoor background lighting.</p>		
<p>Beach/Snow</p> <p>Captures the brightness of such subjects as snowfields, beaches, or sunlit expanses of water.</p>		
<p>Sunset</p> <p>Preserves the deep hues seen in sunsets and sunrises.</p>		

Setting Icons

The icons to the right of the scene name indicate (in order from left to right) the default flash (📷 20), self-timer (📷 22), macro close-up (📷 23), focus (see below), and AF-assist (📷 21) settings for that scene. White squares (○) indicate settings that can be changed, solid squares (■) settings that are fixed at the values shown. Default values for the current scene are restored when the camera is turned off or another scene or shooting mode is selected. Focus is shown as follows:

- 📷 Camera focuses on subject in center of frame
- ∞ Camera focuses at infinity. Focus indicator is always displayed in green when shutter-release button is pressed halfway; note, however, that foreground objects may not always be in focus.

The following icons indicate the precautions that may be needed to avoid blur:

- 📵 Hold camera steady
- 🚶 Use tripod

A **NR** icon indicates that pictures may be processed to reduce noise, resulting in increased recording times.

**Dusk/Dawn**

Preserves the colors seen in the weak natural light before sunrise or after sunset.

**Night Landscape**

Slow shutter speeds are used to produce stunning night landscapes.

**Close Up**

Use to photograph flowers, insects, and other small objects at ranges as close as 4 cm (1.6 in.), with the background objects blurred. Camera zooms to macro close-up position. Macro close-up icon () turns green, indicating that camera can focus as close as 4 cm (1.6 in.) to lens. Camera focuses continuously until shutter-release button is pressed halfway to lock focus.

**Museum**

Use indoors where flash photography is prohibited (for example, in museums and art galleries) or in other settings in which you do not want to use the flash. BSS () 65) turns on automatically.

**Fireworks Show**

Slow shutter speeds are used to capture the expanding burst of light from a firework.

**Copy**

Provides clear pictures of text or drawings on a white board or in printed matter such as a business card. Use macro close-up () 23) to focus at short ranges. Colored text and drawings may not show up well.

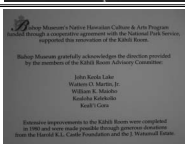











**Back Light**

Use when light is coming from behind a portrait subject, throwing their features into shadow. The flash fires automatically to "fill in" (illuminate) shadows.

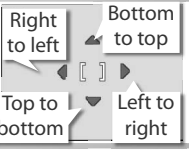

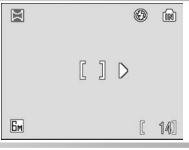

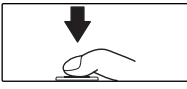
Taking Pictures for a Panorama

<p>1</p>  <p>Highlight  (Panorama assist) in scene menu (▼ 26).</p>		<p>2</p>  <p>Default pan direction displayed.</p> 
<p>3</p> 		<p>Select how pictures will be joined together in completed panorama. This is the direction in which camera will be panned after each shot.</p>
<p>4</p> 		<p>Make selection (to return to step 3, press  button again). Pan direction displayed in white.</p>
<p>5</p> 		<p>Take first shot. About 1/3 of picture is superimposed on view through lens (if pan direction is left to right, picture will appear on side of monitor). AE-L icon is displayed to show that white balance and exposure settings for this picture apply to all shots in series.</p>

6



Compose next shot to overlap with previous picture.

7



Take next shot. Repeat steps 6–7 until all shots in series have been taken.

8



End series. Shooting will also end if a new mode is selected or camera enters standby mode (📷 14).

The camera focuses on the subject in the center of the frame. Use a tripod for better results.

Panorama Assist

Flash mode (📷 20), macro close-up (📷 23), and self-timer (📷 22) can not be adjusted after the first picture is taken. Pictures can not be deleted or zoom or image mode (📷 61) adjusted until shooting is complete. See page 89 for information on how panoramas are stored.

Using Exposure Compensation in Scene Mode

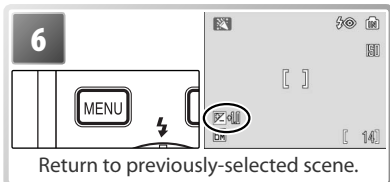
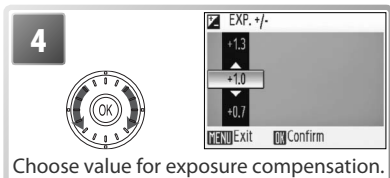
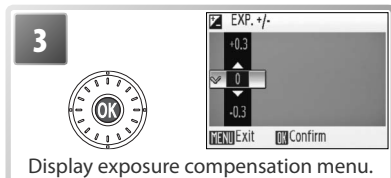
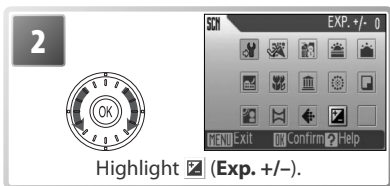
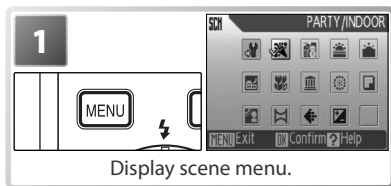

Exposure compensation is used to alter exposure from the value selected by the camera. Choose from values between -2.0EV and $+2.0\text{EV}$. Negative values produce darker pictures, positive values brighter pictures. To choose a value for exposure compensation, select a scene (27–29) and follow the steps below.







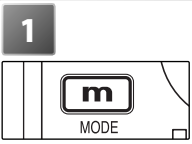

Exposure compensation for the current scene will be reset to 0 when the camera is turned off or another scene or shooting mode is selected.



Scene Assist Mode



Compose pictures with the help of framing guides displayed in the monitor.

1  
Display shooting mode menu.

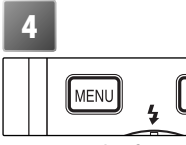



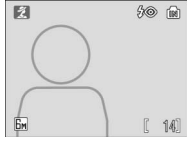

2  
Highlight , , or .

3  
Select and exit to selected mode.

4  
Display framing assist menu.

5  
Highlight composition type.*

6  
Select and return to shooting mode.

*  camera setup ( 70);  select image-mode ( 61);  adjust exposure ( 31)

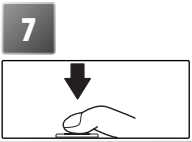
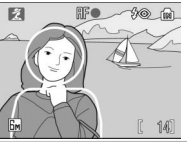
7   Take pictures. If framing guides are displayed, position subject in guides before shooting.

Portrait Assist: Use for smooth, natural-looking portraits.



PORTRAIT	No guides are displayed. Camera sets focus and exposure for subject in center focus area.
Portrait Left	Compose shot with subject in left or right half of frame.†
Portrait Right	Compose shot with subject in left or right half of frame.†
Portrait Close-up	Compose shot with face in top half of frame.†
Portrait Couple	Compose shot with two subjects side-by-side.†
Portrait Figure	Compose shot in "tall" orientation.†



* AF-assist available in **PORTRAIT** mode.

† Camera sets focus and exposure for subject in framing guides.

Landscape Assist: Use for vivid landscapes or portraits that feature a landmark in the background.



LANDSCAPE	No guides are displayed. Use to focus on distant objects through foreground objects such as windows or a screen of branches.†
Scenic View	Compose shot with sky in top third of frame. Match skyline with wavy yellow guide.†
Architecture	Photograph buildings. Framing grid helps keep verticals and horizontals aligned with the frame.†
Group Right	Compose shots with landmark to left or right of portrait subjects. Camera sets focus and exposure for portrait subjects.
Group Left	Compose shots with landmark to left or right of portrait subjects. Camera sets focus and exposure for portrait subjects.

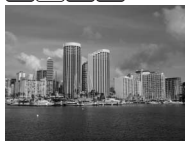

Scene and Scene Assist Modes

* In **Group Right** and **Group Left** modes, flash mode is automatically set to **AUTO**; other modes can be selected.

† Camera focuses at infinity. Focus indicator (16) is always displayed in green when shutter-release button is pressed halfway; note, however, that foreground objects may not always be in focus.

Sports Assist: Capture motion in a series of high-speed shots. No framing guides are displayed. Focus, exposure, and white balance for all pictures are determined by the first shot in each series.



	<p>While shutter-release button is held down, camera shoots about 2.2 frames per second (fps) until icon is displayed. Camera focuses continuously even when shutter-release button is not pressed.</p>
	<p>As above, except that camera focuses at about 4.5 m/15 ft. (6 m/20 ft. at maximum zoom) to infinity for improved shutter response.</p>
	<p>Each time shutter-release button is pressed, camera takes 16 shots in about 2 seconds and arranges them in single picture (1,600×1,200 pixels) in size. Camera focuses continuously even when shutter-release button is not pressed.</p>







Night Portrait Assist: Use for a natural balance between the main subject and background lighting in portraits shot at night. This mode offers the same assist options as portrait assist mode. To prevent blurring, mount the camera on a tripod or rest it on a flat, stable surface.



* AF-assist available in **NIGHT PORTRAIT** mode.

Recording Movies

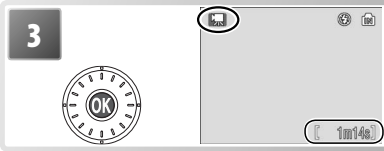
To shoot movies with sound recorded via the built-in microphone, select shooting mode and follow the steps below (no sound is recorded for time-lapse movies). Movies recorded to internal memory at the default setting of **Small Size 320** can be up to 1 minute 14 seconds long; a 256 MB memory card can hold up to 14 minutes 30 seconds.

<p>1</p>  <p>MODE</p>	 <p>SHOOTING</p> <p>Confirm</p>	<p>2</p>  <p>MOVIE</p> <p>Highlight</p>
<p>3</p> 	<p>Select and exit to movie mode. Exposure count display shows maximum total length of movie that can be recorded.</p> <p>1m14s</p>	
<p>4</p> 	<p>Press shutter-release button all the way down to start recording. Progress bar shows amount of memory remaining. Press shutter-release button all the way down a second time to end recording.</p> <p>1m10s</p>	

Recording Movies

The flash (20) turns off in all modes except **Time-lapse movie**. The self-timer (22) can not be used. Optical zoom can not be adjusted during recording; digital zoom is available to a maximum of 2x (15).







If the camera is pointed at the sun or other bright light source during recording, vertical comet-like streaks (“smear”) may appear in the movie. Avoid pointing the camera at bright light sources when filming movies.

More on Movies

See the Appendix for information on how movie files are stored (89), the maximum total length of movie that can be recorded at different settings (88), and movie menu defaults (87).







The Movie Menu

Pressing the **(MENU)** button in movie mode displays the movie menu. Options chosen in this menu are restored the next time movie mode is selected.

Option	Description
 SET UP	Display setup menu  70).
 Movie options	Choose type of movie that will be recorded (see below).
 Auto-focus mode	Choose how camera focuses in movie mode  37).
 Electronic VR	Reduce effects of camera shake  37).

Movie Options

The following options are available:

Option	Size (pixels)	Frames per second
 TV movie 640*	640 × 480	30
 Small size 320*	320 × 240	30
 Small size 320	320 × 240	15
 Pictmotion 320*	320 × 240	15
 Smaller size 160	160 × 120	15
 Time-lapse movie*	640 × 480	30

* Maximum length is 60 s, making movie suitable for use with Pictmotion  48).

Time-Lapse Movie: Record flowers opening or butterflies emerging from cocoons. The camera takes up to 1800 stills at specified intervals and joins them into a silent movie up to sixty seconds long. Charge the battery before shooting begins.

Selecting **Time-lapse movie*** displays the menu shown in Step 1, below.

1

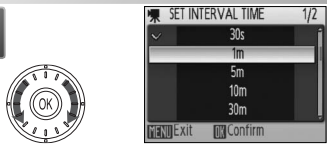

Choose interval between shots.

2

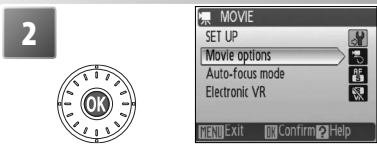

Select and exit to movie options menu.
Press **(MENU)** button to exit menu.

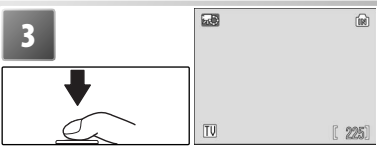

3



Press shutter-release button all the way down to start recording. Camera will take pictures at specified interval until shutter-release button is pressed again, memory is full, or 1800 frames have been recorded. Monitor turns off and indicator lamp blinks green between shots.

Auto-focus Mode

Choose how the camera focuses in movie mode.

Option	Description
 Single AF	Camera focuses when shutter-release button is pressed halfway and locks at this position during shooting, preventing sound of camera focusing from interfering with recording.
 Full-time AF	Camera constantly adjusts focus, even when shutter-release button is not pressed.



Electronic VR

Choose **On** to reduce the effects of camera shake in all movie modes except **Time-lapse movie**. An electronic VR indicator is displayed in the monitor when electronic VR is on ( 6–7).









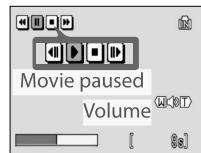

Movie Playback

In full-frame playback ( 41), movies are indicated by a  icon.



To play a movie, display it in full-frame playback and press the  button. Playback controls appear at the top of the display; press the rotary multi selector left or right to highlight a control, then press the  button to perform the selected operation.



Control	Description
	Movie rewinds while  button is pressed.
	Movie advances while  button is pressed.
	Pause playback. Rotate rotary multi selector for single-frame advance or rewind.
	Go ahead one frame. Advance continues while  button is pressed.
	Go back one frame. Rewind continues while  button is pressed.
	Resume playback.
	End movie and return to full-frame playback.













Volume is displayed when the zoom control is pressed. Select **W** to lower volume, **T** to increase. Rotate the rotary multi selector to fast forward or rewind while the movie is playing. To delete a movie, display it in full-frame playback or select it in the thumbnail list and press the  button. A confirmation dialog will be displayed.

Voice Recordings



Audio voice recordings can be recorded over the built-in microphone and played back over the built-in speaker.

Making a Voice Recording

To make a voice recording, select shooting mode and follow these steps:

1  MODE		2  Highlight  .								
3 		Select and exit to voice recording mode. Display shows length of recording that can be made.								
4 		<table border="0"><tr><td>1 Recording indicator</td><td>5 Time remaining</td></tr><tr><td>2 File number</td><td>6 Index number[†]</td></tr><tr><td>3 Length of recording</td><td>7 Progress indicator</td></tr><tr><td>4 Date of recording</td><td></td></tr></table>	1 Recording indicator	5 Time remaining	2 File number	6 Index number [†]	3 Length of recording	7 Progress indicator	4 Date of recording	
1 Recording indicator	5 Time remaining									
2 File number	6 Index number [†]									
3 Length of recording	7 Progress indicator									
4 Date of recording										
Press shutter-release button all the way down to start recording.*										
* Camera enters stand-by mode (14) and indicator lamp turns green. Press  to reactivate display. To pause recording, press  button; self-timer and indicator lamps will blink. Press again to resume.										
† To create index, press rotary multi selector up, down, left, or right during recording. Camera can skip to any index during playback. Start of recording is index number 01; other numbers are assigned in ascending order, to maximum of 98.										
5 		Press shutter-release button all the way down a second time to end recording. Recording will end automatically after five hours or when no more memory is available.								

Voice Recordings

See the Appendix for information on how voice recordings are stored ( 89) and on the maximum total length of voice recording that can be stored ( 88).

The Voice Recording Menu

Pressing the **MENU** button in voice recording mode displays the following options. The option selected for **Sound quality** is restored the next time voice recording mode is selected.

Option	Description
SET UP	Display setup menu (70).
Sound quality	Select High for high quality, Normal for reduced file size.

Playing Voice Recordings

To play voice recordings back, select playback mode and follow these steps.

1

Display playback mode menu.

2

Highlight .

3

Display list of voice recordings.

4

Select recording.

5

Play recording. Rotate rotary multi selector to advance or rewind. To delete recording, press button. Press to exit playback and return to recording mode.

1 Control icons*

2 File number

3 Playback time

4 Index number

5 Progress indicator

6 Date of recording

7 Length of recording

8 Volume†

9 Index

* Press rotary multi selector left or right to highlight control, press **OK** button to select.



	Pause playback.
	Resume playback.
	Advance recording. Playback resumes when rotary multi selector is released.
	Rewind recording. Playback resumes when rotary multi selector is released.
	Return to start of current index.
	Skip to next index.
	End playback and return to voice recording list.

† Zoom control controls volume. Select **W** to lower volume, **T** to raise volume.

Copying Voice Recordings

To copy voice recordings between internal memory and a memory card, display the voice recording list shown in Step 3 on the preceding page and press the **MENU** button. This option is available only when a memory card is inserted.



1



Highlight option:

- **Internal to Card**: Copy recordings from internal memory to memory card
- **Card to Internal**: Copy recordings from memory card to internal memory

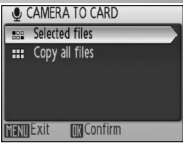
2



Display menu of copy options.

3



Highlight **Selected files**.*



* To copy all voice recordings, highlight **Copy all files** and press **OK** button. Confirmation dialog will be displayed; highlight **Yes** and press **OK** button.

4



Display list of voice recording files.

5





Highlight file.

6

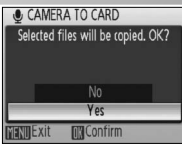

Confirmation dialog displayed.

7



Highlight **Yes** and press **OK** button to copy file.

Voice Recordings

PictureProject can not be used to transfer or play voice recordings. Select **Interface > Mass storage** for **USB**, copy the files manually, and then play them back using QuickTime or any other WAV-compatible audio player. Note that index points created with the camera can not be used when voice recordings are played back on another device.

The COOLPIX S5 may be unable play or copy sound files created with other devices.

Viewing Pictures on the Camera

To view pictures full-frame in the monitor (*full-frame playback*), press the button (if the camera is off, pressing the button for about a second will turn the camera on in playback mode). The following operations can be performed:

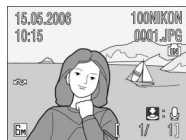

To	Press	
View other pictures		19
Delete picture		—
Zoom picture in	T (Q)	42
View thumbnails	W	—
View playback mode menu	m	5

To	Press	
View playback menu	MENU	67
Record/play voice memo	Shutter button	44
Enhance contrast		43
Movie: Play movie	OK	37
Exit to shooting mode		—

Viewing Multiple Pictures: Thumbnail Playback

Pressing the zoom control to **W** in full-frame playback displays pictures in “contact sheets” of four, nine, or sixteen thumbnail images. The following operations can be performed while thumbnails are displayed:



To	Press	
Highlight picture		19
Change number of pictures displayed	W / T (Q)	—
Delete highlighted picture		—

To	Press	
Exit to full-frame playback	OK	—
View playback mode menu	m	5
View playback menu	MENU	67
Enhance contrast		43
Exit to shooting mode		—

Deleting Pictures

Pressing the button in full-frame or thumbnail playback displays the dialog shown at right. Highlight **Yes** and press the **OK** button to delete the selected picture.



Viewing Pictures in Internal Memory

Pictures in internal memory can only be viewed if no memory card is inserted.

Taking a Closer Look: Playback Zoom

Pressing the zoom control to **T** during full-frame playback zooms the current picture in 3×, with the center of the picture displayed in the monitor (Quick Playback Zoom). The following operations can be performed while pictures are zoomed in:

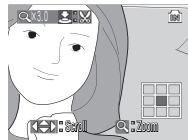

Playback zoom display. Note that “tall” orientation pictures are displayed in “wide” orientation when zoomed in. Select **T** once to display picture in “wide” orientation, again to zoom picture in 3×.

To	Press	
Zoom in (maximum 10×)	T (Q)	—
Zoom out	W (R)	—
View other areas of picture		—
Delete picture		41
Exit to full-frame playback		41
View mode menu	m	5
View playback menu	MENU	67
Create cropped copy (see below)	Shutter button	—
Exit to shooting mode		—

Creating a Cropped Copy

If a icon is displayed in the monitor during playback zoom, the portion of the picture currently visible in the monitor can be saved to a separate file. Pressing the shutter-release button displays the dialog shown at right; highlight **Yes** and press the button to create a new picture containing only the area visible in the monitor.



Cropped copies are stored as JPEG files with a compression ratio of 1:8. Depending on the size of the original and the zoom ratio at the time the copy was created, copies will be 2,592×1,944 () , 2,048×1,536 () , 1,600×1,200 () , 1,280×960 () , 1,024×768 () , 640×480 () , 320×240 () , or 160×120 () pixels in size.

Cropped Copies

See the Appendix for more information on cropped copies (89).

Auto Power off (Stand-by Mode)

At default settings, the monitor will turn off if no operations are performed for about a minute during playback (stand-by mode; 75). The camera will turn off automatically if no operations are performed for another three minutes.

Enhancing Contrast: D-Lighting

Pressing the  button during full-frame or thumbnail playback creates a copy of the current picture with enhanced brightness and contrast, brightening dark and backlit subjects.



Before



After

1



Confirmation dialog displayed.

2



Highlight OK.

3

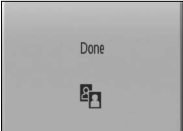

Done

Create copy.

During playback, copies created with D-Lighting are indicated by a  icon ( 6–7).

D-Lighting

See the Appendix for more information on D-Lighting copies ( 89).

Voice Memos: Recording and Playback

The built-in microphone (📷 2) can be used to record voice memos for pictures marked with a 🗣️📷 icon in full-frame playback (📷 41).

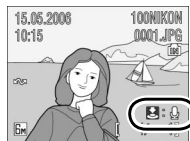

Recording Voice Memos

To record a voice memo, press and hold the shutter-release button. Recording ends after about 20 seconds or when the button is released. Do not touch the microphone during recording. Note that if a voice memo already exists for the current picture, it must be deleted before a new voice memo can be recorded.

Playing Voice Memos

During playback, pictures to which a voice memo has been appended are indicated by a 🗣️📷 icon (📷 6–7). Press the shutter-release button to start and stop playback. Volume is controlled by the zoom control. Select **W** to lower volume, **T** to increase.

Deleting Voice Memos

To delete the voice memo for the current picture, press the 🗑️ button. The dialog shown at right will be displayed; rotate the rotary multi selector to highlight an option and press the **OK** button to select.

- **No**: Exit without deleting the picture or voice memo.
- **[🗣️📷]**: Delete voice memo only.
- **Yes**: Delete both picture and voice memo.



🗣️ Voice Memos

Voice memos can not be added to pictures created with other types of camera. Voice memos recorded using other types of camera can not be played back on the COOLPIX S5. See the Appendix for more information on voice memos (📷 89).

Viewing Pictures by Date

In full-frame and thumbnail playback, pictures taken on selected dates can be selected for viewing, deletion, printing, protection, and transfer.

Calendar Mode: Choose a date from a calendar.

1



MODE

Display playback mode menu (OK/5).

2



CALENDAR

Highlight **Calendar** (OK).

3

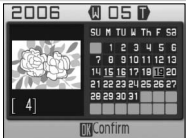

2006 05 T

SU M TU W Th F Sa

1 2 3 4 5 6

7 8 9 10 11 12 13

14 15 16 17 18 19 20







21 22 23 24 25 26 27

28 29 30 31

[4]

OK-confirm



Dates for which pictures exist are underlined in yellow. The following operations can be performed:

To	Press	Icon
Select month (keep control pressed for quick scroll)	W/T	—
Highlight date (only if pictures exist for more than one date)		—
View pictures taken on date		47
Delete all pictures taken on date		41
View playback mode menu		5
View playback menu		46
Exit to shooting mode		—

Calendar/List by Date





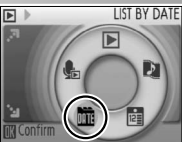

The camera lists a maximum of 9,000 pictures for each date. Dates with more than 9,000 pictures are indicated by an asterisk ("*"). Pictures taken while the camera clock is not set are not displayed.

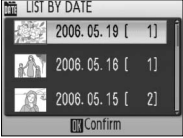
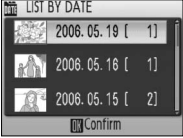
List-by-Date Mode: Choose a date from a list.

1   **Display playback mode menu (5).**

2   **Highlight List By Date (DATE).**

3   **View dates for which pictures exist. The following operations can be performed:**

To	Press	
Highlight date		—
View pictures taken on date		47
Delete all pictures taken on date		41
View playback mode menu		5
View playback menu		—
Exit to shooting mode		—

* Camera lists up to 30 dates. If pictures exist for more than 30 dates, all pictures recorded earlier than most recent 29 dates will be listed together as **Others**.

Pressing the  button in the calendar or date list displays the options listed at right. These options apply to all pictures taken on the currently selected date.

Option	
Print set	59
Slide show	68
Delete	68
Protect	68
Transfer marking	68

Print Set/Transfer Marking

Selecting **Print set** or **Transfer marking** from the menu for the calendar or date list displays a confirmation dialog. Selecting **Yes removes existing print or transfer marking from all pictures in internal memory or on the memory card**, ensuring that only pictures taken on the selected date are selected for printing or transfer.

Viewing Pictures

To view pictures taken on a selected date, highlight the date in the calendar or date list and press the **OK** button. The first picture for that date will be displayed full frame, with **DATE** (calendar mode) or **DATE** (list-by-date mode) displayed in the top left corner, and the date and time of recording displayed in place of the folder name and file number and type (6–7). The following operations can be performed:



To	Press	Eye icon
View other pictures taken on same date		19
Delete picture		41
Zoom picture in	T (Q)	42
View playback mode menu	m	5

To	Press	Eye icon
View playback menu	MENU	—
Record/play voice memo	Shutter button	44
Enhance contrast		43
Movie: Play movie	OK	37
Return to date list	W (checkered)	—
Exit to shooting mode		—

Pressing the **MENU** button in full-frame playback displays the options listed at right. These options apply only to the picture currently displayed full frame, although other pictures taken on the same date can be selected.

















Option	Eye icon
Print set	59
Slide show	68
Delete	68
Protect	68
Transfer marking	68
Small pic.	69

Pictmotion by muvee

Pictmotion creates slide show movies with custom transitions and background music. *It is only available when a memory card is inserted in the camera.*

Creating a Pictmotion Movie

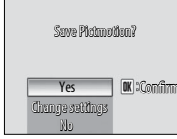
To create a simple movie using the ten most recent pictures during full-frame or thumbnail playback:

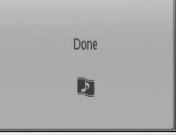
1  Display playback mode menu (5).	 PLAY Confirm
2  Highlight Pictmotion (2).	 Pictmotion by muvee Confirm
3  Display options.	 Confirm
4  Highlight All .	 Confirm
5  Display options.	 PICTURE SELECTION All Images Choose date Confirm Confirm
6  Highlight All images .	 PICTURE SELECTION All Images Choose date Confirm Confirm
7  View Pictmotion.	
8  When dialog is displayed, highlight Yes .	 Save Pictmotion? Yes change settings No Confirm
9  Done	 Done

To create a custom Pictmotion movie:



Select **5**



All images
(Confirm off)



Press **OK**



To choose style, background music, playback order, and number of slides for new movie, press **MENU** button and make selections in Pictmotion settings dialog (**5** 50). Press **OK** when done.



All images (Confirm on)

Choose date

Confirm on

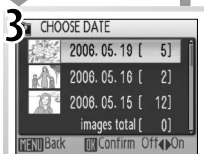

Rotate rotary multi selector to highlight date, press left or right to select. Press **OK** when done.

Confirm off

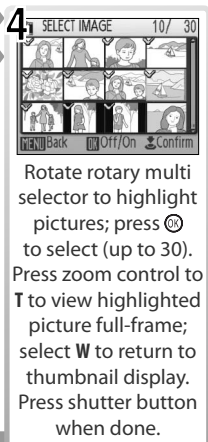

* Place hand behind speaker for better sound.

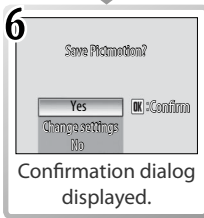
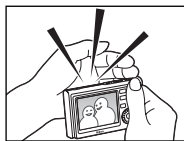

Yes

Save Pictmotion

No

Return to
Step 1

Change settings

Other Options (Steps 1 and 7 on Page 49)

Rotate the rotary multi selector to highlight options, press left or right to change. Press the **OK** button to exit when done.

Music: Choose from Pachelbel's Canon, Scarborough Fair, Pomp and Circumstance March, Turkish March, and Grandfather's Clock; press zoom control to **T** to preview selected track (pre-installed tracks only). Up to three custom tracks can be added using PictureProject (Windows only; see below).

Style: Choose from **Motion**, **Moody**, **Pro-Slow**, **Pro-Fast**, and **Classic**. Press zoom control to **T** to preview selected style.

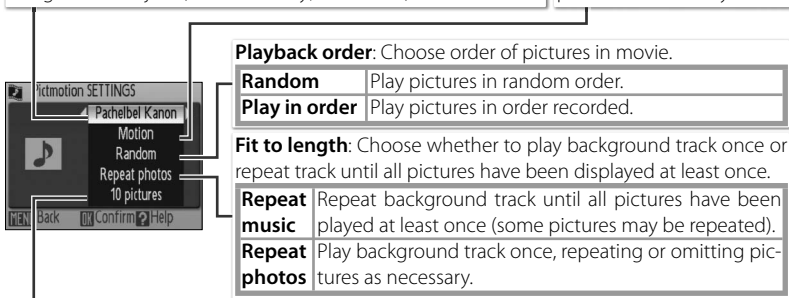

The screenshot shows the Pictmotion SETTINGS menu with the following options: Pachelbel Kanon, Motion, Random, Repeat photos, 10 pictures, Back, Confirm, and Help. Callout boxes provide details for several options:

- Playback order:** Choose order of pictures in movie.

Random	Play pictures in random order.
Play in order	Play pictures in order recorded.
- Fit to length:** Choose whether to play background track once or repeat track until all pictures have been displayed at least once.

Repeat music	Repeat background track until all pictures have been played at least once (some pictures may be repeated).
Repeat photos	Play background track once, repeating or omitting pictures as necessary.

Auto select: This option is only available if **MENU** button is pressed in Step 1 (49). Choose from 10, 20, 30 or **No auto select**. This will be number of slides in slide show if **Confirm** is not selected in Step 2. If **Confirm** is selected in Step 2, specified number of images will be selected in Step 4, starting with most recent picture. Follow instructions in Step 4 to change selection.

Pictmotion

If the current memory card holds twenty Pictmotion movies, no additional movies can be created until an existing movie has been deleted.

The pictures in a Pictmotion movie are automatically protected when the movie is saved (68). Protection is not removed when the Pictmotion is deleted. Protected pictures are marked with a **lock** icon in full-frame and thumbnail playback (6–7).

Pictmotion supports both still pictures and movie files; note, however, that in the case of movies only a small portion selected from the first sixty seconds of each movie will be included.



PictureProject

The supplied PictureProject software can be used to transfer Pictmotion movies to a computer for viewing and to copy up to three three-minute custom sound tracks to a memory card (*Windows only; not available on Macintosh computers*). Before copying sound tracks to the computer, set the **Interface > USB** option in the camera setup menu to **Mass Storage** (76). See the PictureProject reference manual (on CD) for details.

Viewing Pictmotion Movies

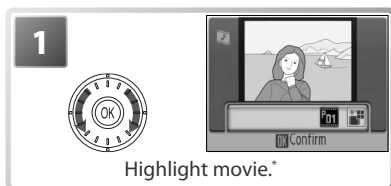
To view Pictmotion movies, display the Pictmotion menu as described in Steps 1–3 on page 48 and follow the steps below.



* To delete highlighted movie, press  button. Confirmation dialog will be displayed; highlight **Yes** and press .



† If **Loop** option is selected, movie will repeat automatically. To select or deselect **Loop** option, highlight **Loop** and press .

‡ Zoom control controls volume. To pause playback, press .

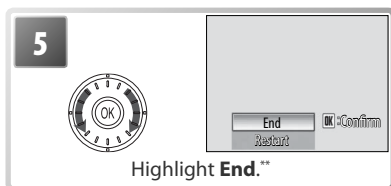
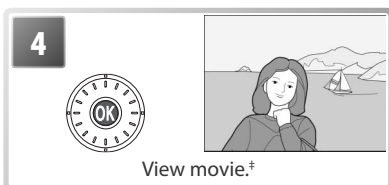

To resume playback, highlight **Restart and press .

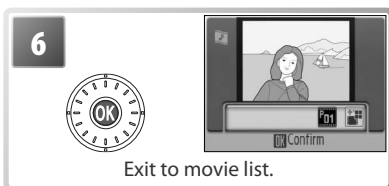

See the Appendix for information on how Pictmotion movies are stored ( 89).

Connecting to Televisions, Computers, and Printers

In addition to viewing pictures on the camera, you can also:

- View pictures on TV and record movies to video (see below)
- Copy pictures to a computer for storage and editing (📷 52–54)
- Print pictures on a home printer (🖨️ 55) or order prints from photofinisher

Before connecting the camera to another device, it may be necessary to change the **Interface** settings in the setup menu (📷 54, 76). To prevent the camera from turning off unexpectedly during connection, use fully charged batteries or the supplied AC adapter.

Viewing Pictures on TV

- 1 Check that the option selected for **Interface > Video mode** matches the device to which the camera will be connected (📷 76), and then turn the camera off.



- 2 Connect the COOL-STATION to the TV using the supplied A/V cable. Connect the black plug to the COOL-STATION, the yellow plug to the video-in jack on the TV, and the white plug to the audio-in jack.

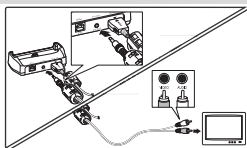

- 3 Tune the television to the video channel. If in doubt, consult the documentation for the TV.
- 4 Place the camera in the COOL-STATION and press the (📷) button for about a second to turn the camera on. The camera monitor will remain off and the television will show the image normally shown in the monitor.

Viewing Pictures on a Computer

Before pictures can be transferred (copied) to a computer, PictureProject must be installed. For more information on installing and using PictureProject, see reference CD and *Quick Start Guide*. To transfer pictures to a computer:

- 1 Start a computer to which PictureProject has been installed.
- 2 Choose an **Interface > USB** option as described in "Choosing a USB Option for Connection to a Computer" (📷 54) and then turn the camera off.

- 3 Connect COOL-STATION to the computer using the supplied USB cable.

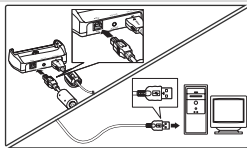

- 4 Place the camera in the COOL-STATION and turn it on.



- 5 Press the **OK** (OK) button* to copy all marked pictures to the computer. The following messages will be displayed:

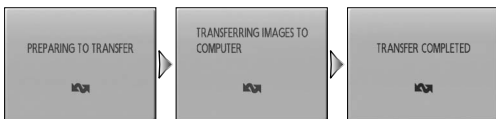

* Note that the **OK** button can not be used to transfer pictures if the memory card is locked (13) or if **Mass Storage** is selected for **USB** and no memory card is inserted. Transfer pictures using the PictureProject **Transfer** button (see below). Pictmotion movies can be transferred using PictureProject (50).

- 6 The pictures will be displayed in PictureProject when transfer is complete. Disconnect the camera as described in "Disconnecting the Camera" (54).

Marking Pictures for Transfer

Pictures marked for transfer are shown by a  icon during playback. By default, all pictures are automatically marked for transfer. Two options control transfer marking:

- **Interface > Auto transfer** (setup menu): Choose **On** to mark all new pictures for transfer (76).
- **Transfer marking** (playback menu): Change marking for existing pictures (68).

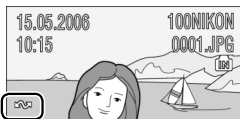

The PictureProject Transfer Button

To copy both marked and unmarked pictures to the computer, click the PictureProject **Transfer** button instead of pressing the **OK** button in Step 5. See the *Quick Start Guide* or PictureProject reference manual (on CD) for details.



Choosing a USB Option for Connection to a Computer

Consult the following table when choosing a USB option for connection to a computer (52). The default option is **PTP**. For more information on menu operations, see “Using Menus” (17).



Computer operating system	Pictures transferred using:	
	Camera button*	PictureProject Transfer button
Windows XP	Choose Mass Storage or PTP .	
Windows 2000 Professional Windows Millennium Edition (Me) Windows 98 Second Edition (SE)	Choose Mass Storage .†	
Mac OS X 10.1.5 or later	Choose PTP .	Choose Mass Storage or PTP .

* Can not be used to transfer pictures if memory card is locked (13) or if **Mass Storage** is selected for **USB** and no memory card is inserted. Use PictureProject **Transfer** button. Pictmotion movies can be transferred using PictureProject (50).

† Do not select **PTP**. If **PTP** is selected when the camera is connected, wait until the Windows hardware wizard is displayed, then click **Cancel** and disconnect the camera. Select **Mass Storage** in the camera **USB** menu before reconnecting the camera.

Disconnecting the Camera

If **PTP** is selected for **USB**, turn the camera off and disconnect the USB cable.

If **Mass Storage** is selected for **USB**, remove the camera from the system as described below before turning the camera off and disconnecting the USB cable.

- **Windows XP Home Edition/Windows XP Professional:** Click the “Safely Remove Hardware” icon () in the taskbar and select **Safely remove USB Mass Storage Device**.
- **Windows 2000 Professional:** Click the “Unplug or Eject Hardware” icon () in the taskbar and select **Stop USB Mass Storage Device**.
- **Windows Millennium Edition (Me):** Click the “Unplug or Eject Hardware” icon () in the taskbar and select **Stop USB Disk**.
- **Windows 98 Second Edition (SE):** In My Computer, right click on the removable disk corresponding to the camera and select **Eject**.
- **Macintosh:** Drag the untitled camera volume (“NO NAME”) into the Trash.



Printing Pictures

Users of PictBridge- or ImageLink-compatible printers can connect the camera directly to the printer and print pictures without using a computer.

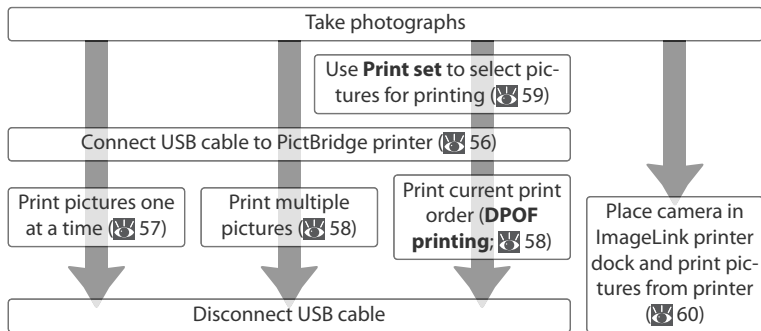

Other Ways to Print Pictures

Pictures can also be printed by:

- **Inserting a memory card in the printer:** If the printer is equipped with a card slot, a memory card can be inserted in the printer and pictures printed directly from the card. If the printer supports DPOF, the camera **Print set** option can be used to select pictures for printing (59). See the printer manual for details.
- **Taking memory cards to a digital print service:** If the service supports DPOF, the camera **Print set** option can be used to select pictures for printing (59).
- **Transferring pictures to a computer:** Once transferred to a computer (52–53), pictures can be printed using imaging software. See the application and printer manuals for details.

Printing the Date of Recording on Pictures

Two options are available for printing the date of recording on pictures: **Date imprint** (74) and **Print set > Date** (59).

Date imprint	Print set > Date
Must be set before picture is taken	Set after picture is taken
Date permanently imprinted on picture	Date stored separately
Date appears whenever picture is printed	Date only appears when picture is printed on DPOF-compatible printer

The date only appears once; **Print set > Date** can not be used to print two dates on pictures with a date imprint.

Connecting the Printer

1 Turn the camera off.

USB

PTP (the default option) must be selected for **Interface > USB** in the camera setup menu before the camera can be connected to a printer (▶ 76).

2 Connect COOL-STATION to the printer using the supplied USB cable.

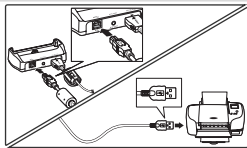

3 Turn the printer on.

4 Place the camera in the COOL-STATION and turn it on. A PictBridge start-up screen will be displayed. The camera will then enter full-frame playback with the PictBridge logo displayed in the monitor.

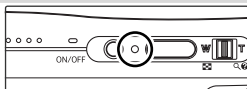

Printing Pictures One at a Time

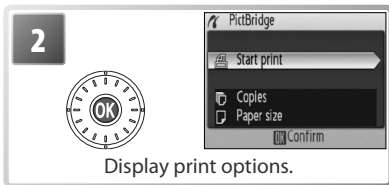
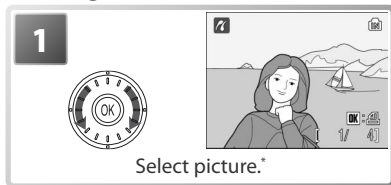

* To choose picture from thumbnail list, press zoom control to **W** () and use rotary multi-selector to highlight desired picture, or press zoom control to **T** (Q) to exit to full-frame playback.

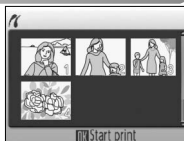

3 Highlight option and press **OK**:

Option	Description
Start print	Start printing. To cancel before all copies have been printed, press OK . Camera returns to PictBridge playback display when printing is complete; repeat from Step 1 to print additional pictures.
Copies	Choose number of copies (up to 9).
Paper size	Choose from Default (the default page size for the current printer), 3.5 x 5 in. , 5 x 7 in. , Postcard , 100x150mm , 4 x 6 in. , 8 x 10 in. , Letter , A4 , and A3 . Only sizes supported by the current printer will be displayed.

Paper Size

Paper size can not be selected from the camera if the printer does not support the page sizes used by the camera or the printer automatically selects the page size. Use the printer to select page size.

Printing Multiple Pictures

To print multiple pictures, press the **MENU** button while the PictBridge playback screen is displayed (56). The menu shown at right will be displayed; highlight an option and press the **OK** button.

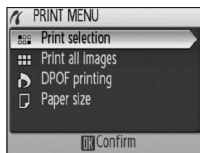

Option	Description
Print selection	Print selected pictures (see below).
Print all images	Print one copy of all images.
DPOF printing	Menu shown at right displayed. Highlight option and press OK : <ul style="list-style-type: none">• Start print: Print current print order (59).• Confirm: View print order (59, Step 4). Press OK to start printing, or press MENU to exit.• Cancel: Exit without printing.
Paper size	Choose page size (57, Step 3).



Printing Selected Pictures

Choosing **Print selection** displays the menu shown in Step 1.

1



Scroll through pictures. Current picture shown at center of display.

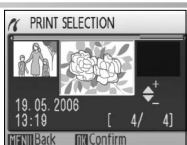

2



Select picture and set number of prints to 1. Selected pictures marked by icon.

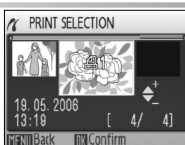

3



Choose number of prints (up to 9). To deselect picture, press rotary multi selector down when number of prints is 1. Repeat steps 1–3 to select additional pictures.

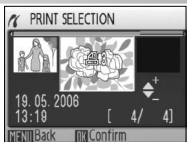

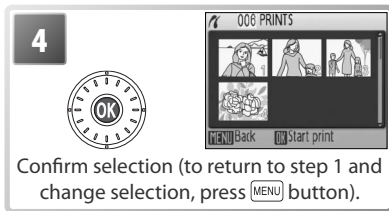

* Press **OK** again to cancel before printing is complete.

Creating a DPOF Print Order: Print Set

The **Print set** option in the playback menu (📷 67) is used to create digital “print orders” for printing on DPOF-compatible devices (📷 86). Selecting **Print set** displays the menu shown in Step 1.

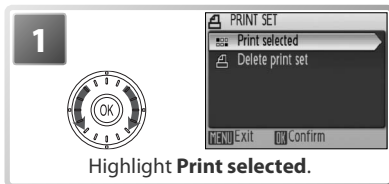

* To delete current print order, highlight **Delete print set** and press **OK**.

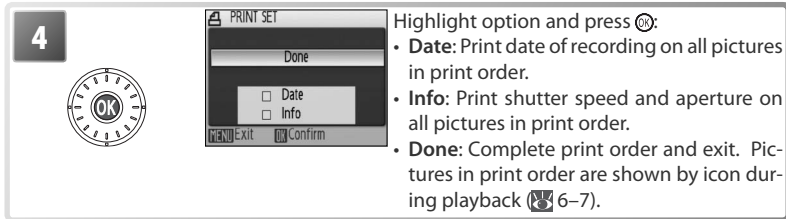
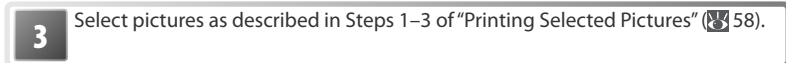

Print Set

Date and **Info** are reset each time the menu shown Step 4 is displayed. **Info** is not printed when the camera is connected directly to the printer.

ImageLink

Use the supplied PV-10 dock insert to print pictures on an ImageLink printer (86). See the printer manual for details.

- 1 Attach the dock insert to the printer.

USB

PTP (the default option) must be selected for **Interface > USB** in the camera setup menu before the camera can be connected to a printer.

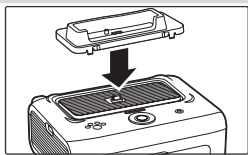

- 2 Turn the camera off and attach it to the dock insert. The camera will turn on automatically.

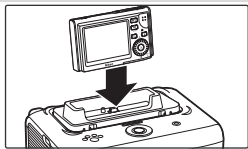

- 3 Print pictures as described in the printer manual.

To remove the dock insert, place your thumbs where indicated, press, and lift.

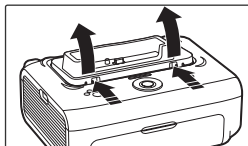

ImageLink







The monitor will turn off automatically if no operations are performed for about one minute while the camera is connected to an ImageLink printer. If no operations are performed for another seven minutes, the camera will turn off.











If the printer does not support the language selected in the camera setup menu, menus will be displayed in English.

Menu Guide

This section describes the menus available for shooting, playback, and camera setup. See page 17 for information on using the menus.

Shooting Options: The Shooting Menu





To display the shooting menu, select  mode ( 18) and press the  button. With the exception of **Image mode**, the following options are available only in  mode. Unless **Reset all** ( 76) is used to reset settings to their default values ( 87), settings in this menu will be restored the next time  mode is selected.

Option	Description	
 SET UP	Display the setup menu.	70
 Image mode	Choose image size and quality.	61
 White balance*	Match white balance to the light source.	62
 Exp. +/-	Adjust exposure for very bright or very dark subjects.	63
 Continuous*	Take pictures one at a time or in a sequence.	63
 BSS*	Use BSS to choose the sharpest picture.	65
 Sensitivity	Control camera's sensitivity to light.	65
 Color Options*	Control color.	66
 AF area mode	Choose where the camera focuses.	66

* See the Appendix for information on restrictions that may apply to these settings ( 88).

Image Mode

Pictures taken with a digital camera are recorded as image files. The size of the files, and with it the number of images that can be recorded ( 88), depends on the *size* and *quality* of the images (image mode). Before shooting, choose an image mode according to how you plan to use the picture.

Option	Size (pixels)	Description
 High (2816*)	2,816 × 2,112	Pictures are compressed less than Normal , producing higher quality images.
 Normal (2816)	2,816 × 2,112	Best choice in most situations.
 Normal (2048)	2,048 × 1,536	Smaller size allows more pictures to be stored.
 PC screen (1024)	1,024 × 768	Suited to computer display.
 TV screen (640)	640 × 480	Suited to e-mail or television viewing.







The current setting is shown by an icon in the display ( 6–7).

Shooting Menu Settings

See the Appendix for information on shooting menu defaults ( 87).

WB White Balance

Process pictures to produce natural colors under different types of light.

Option	Description
 Auto	White balance automatically adjusted to suit lighting conditions. Best choice in most situations.
 White bal. preset	Neutral-colored object used as reference to set white balance under unusual lighting conditions (see below).
 Daylight	White balance adjusted for direct sunlight.
 Incandescent	Use under incandescent lighting.
 Fluorescent	Use under most types of fluorescent lighting.
 Cloudy	Use when taking pictures under overcast skies.
 Flash	Use with the flash.

At settings other than **Auto**, the current setting is shown by an icon in the display  (6–7).

PRE Preset White Balance

Preset white balance is used with mixed lighting or to compensate for light sources with a strong color cast (for example, to make pictures taken under a lamp with a red shade look as though they had been taken under white light).

1 Place white or gray reference object under lighting that will be used during shooting.

2



Highlight **White bal. preset**.



3



Camera zooms in.

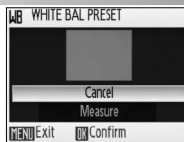

4



Highlight **Measure**.*

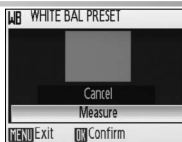

5

Frame reference object here

Frame reference object.

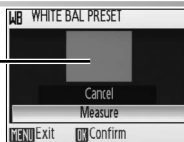

* To restore most recent value for preset white balance, highlight **Cancel** and press .

Preset White Balance

Preset white balance can not be measured with the flash.

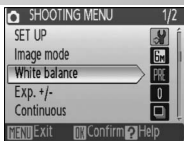







Preset white balance set to new value.

Exp. +/-

Exposure compensation is used to alter exposure from the value selected by the camera. Choose from values between -2.0EV and $+2.0\text{EV}$ in increments of $\frac{1}{3}\text{EV}$. Negative values produce darker pictures, positive values brighter pictures. The effects can be previewed in the display; at settings other than zero, the current value for exposure compensation is also shown ( 6–7).

Continuous

Capture a fleeting expression on a portrait subject, photograph a subject that is moving unpredictably, or capture motion in a series of pictures. At settings of **Continuous** and **Multi-shot 16**, the flash turns off and focus, exposure, and white balance are fixed at the values for the first picture in each series.



Option	Description
 Single	One shot is taken each time shutter-release button is pressed.
 Continuous	While shutter-release button is pressed, camera takes pictures at up to 2.2 frames per second (fps).
 Multi-shot 16	Each time shutter-release button is pressed, camera takes 16 shots at about 2 fps and arranges them in a single picture as shown at right. Image mode set to  Normal (2816) .
 Intvl timer shooting	Camera takes pictures automatically at specified interval ( 64).



Except at **Single**, the current setting is shown by an icon in the display ( 6–7).

Interval Timer Photography

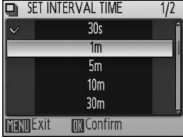
To display the interval timer menu, highlight **Intvl timer shooting** in the CONTINUOUS menu ( 63) and press the **OK** button. To prevent unexpected loss of power, charge the battery before shooting begins.



1			<p>Choose interval between shots. Press OK button to make selection, then press MENU button to return to shooting mode.</p>
2			<p>Press shutter-release button all the way down to start recording. Camera will take pictures at specified interval until shutter-release button is pressed again, memory is full, or 1800 frames have been recorded. Monitor turns off and indicator lamp blinks green between shots.</p>

Interval Timer Photography

See the Appendix for more information on how pictures taken with interval timer photography are stored ( 89).

Best Shot Selector (BSS)

BSS is recommended for situations in which inadvertent camera movement can produce blurred pictures, or when parts of the image are prone to under- or over-exposure. It may not produce the desired results if the subject moves or the composition is changed while the shutter-release button is fully pressed.

Option	Description
 Off	BSS off.
 On	Camera takes shots while shutter-release button is pressed, to a maximum of ten. These images are then compared and sharpest picture (picture with highest level of detail) is saved. Flash turns off automatically and focus, exposure, and white balance for all photos are determined by first picture in each series.
 Exposure BSS	<p>Selecting this option displays sub-menu shown at right. Choose from:</p> <ul style="list-style-type: none"> • Highlight BSS: picture with smallest area of over-exposure is selected. • Shadow BSS: picture with smallest area of underexposure is selected. • Histogram BSS: of pictures with least under- and over-exposure, camera chooses picture with overall exposure closest to optimum. <p>Camera takes five shots each time shutter-release button is pressed, but only picture that best meets selected criterion is saved. Flash turns off automatically and focus and white balance for all photos are determined by first picture in each series. Recommended for high-contrast subjects, when it is difficult to set exposure correctly.</p>



At settings other than **Off**, the current BSS setting appears in the display  (6–7).





Sensitivity

Sensitivity is a measure of how quickly the camera reacts to light. The higher the sensitivity, the less light needed to make an exposure. Much as film with a high ISO rating tends to produce “grainy” images, high sensitivities may however be associated with “noise”—randomly spaced, brightly colored pixels concentrated in dark parts of the image. Choose from values between ISO 50 and 400 equivalent. **Auto** is equivalent to ISO 50 under normal conditions; when lighting is poor and the flash is off, the camera compensates by raising Sensitivity to a maximum of ISO 200 equivalent.

The current Sensitivity is displayed in the monitor at settings other than **Auto**  (6–7). If **Auto** is selected, an **ISO** icon will be displayed when sensitivity is raised above ISO 50 equivalent.

Color Options





Make colors more vivid or record pictures in monochrome.

Option	Description
 Standard color	Natural color.
 Vivid color	Vivid, "photoprint" colors.
 Black-and-white	Take pictures in black-and-white.
 Sepia	Record pictures in sepia.
 Cyanotype	Take pictures in blue-tinted monochrome.

The effects of the selected option can be previewed in the monitor. At settings other than **Standard color**, the current setting is also indicated by an icon in the display ( 6–7).

AF Area Mode

Choose where the camera focuses.

Option	Description
 Center	Camera focuses on subject at center of frame.
 Manual	Press rotary multi selector up, down, left, or right to select from 99 focus areas in large frame shown at right. Pictures can be taken while focus area selection screen is displayed. To end focus area selection and adjust flash, macro close-up, and self-timer settings, press  button. Press  button again to change selection.

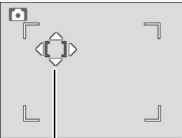

Focus area

Focus Lock

To focus on off-center subjects when **Center** is selected for **AF area mode**:

1



Position subject in center of frame.

2



Press shutter-release button halfway and check focus.

3





Recompose picture with shutter-release button pressed halfway.









4







Take picture.

Playback Options: The Playback Menu

To display the playback menu, press the  button to select playback mode (19) and press the  button. See page 17 for more on using the menus.

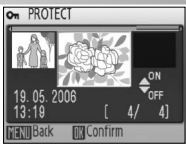
Option	Description	
 SET UP	Display the setup menu.	70
 Print set	Select pictures for printing.	59
 Slide show	View pictures in an automatic slide show.	68
 Delete*	Delete all or selected pictures.	68
 Protect*	Protect selected pictures from accidental deletion.	68
 Transfer marking*	Change transfer marking for existing pictures.	68
 Small pic.	Create a small copy of the current picture.	69
 Copy*	Copy files between memory card and internal memory.	69

* To select multiple pictures for deletion, protection, transfer, or copying:

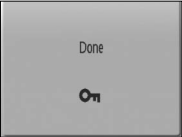
- 
Scroll through pictures. Current picture shown at center of display.

- 
Select current picture. Selection shown by icon.

- Repeat steps 1–2 to select additional pictures. To deselect picture, highlight and press rotary multi-selector down.
- 
Complete operation. Confirmation message may be displayed.

Print Set

Create digital “print orders” for PictBridge printers and devices that support DPOF ( 59).

Slide Show

Selecting **Slide show** displays the following options. Rotate the rotary multi selector to highlight and press the **OK** button to select.

Option	Description
Frame intvl	Choose length of time each slide will be displayed.
Loop	If this option is checked, slide show will repeat until OK button is pressed.
Start	Start slide show.

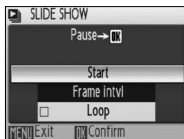

While the slide show is in progress, rotate the rotary multi selector clockwise to skip ahead, counter-clockwise to rewind. To pause the slide show, press the **OK** button.



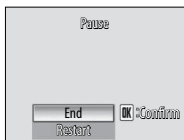

When the slide show ends or is paused, the menu shown at right will be displayed. Highlight **Restart** and press the **OK** button to restart the show, or select **End** to end the show and return to the playback menu.



Delete





Choose **Erase all images** to delete all pictures, **Erase selected image(s)** to select pictures for deletion ( 67). Pictures marked with a  icon will not be deleted.



Protect

Protect selected pictures from accidental deletion. Protected pictures are marked with a  icon ( 6–7) and can not be deleted using the  button or **Delete**. Note, however, that formatting *will* delete protected files ( 76).



Transfer Marking

Mark existing pictures for transfer to a computer ( 53).

Option	Description
 All on	Mark all images for transfer.
 All off	Remove transfer marking from all images.
 Select image(s)	Mark selected pictures for transfer ( 67).



Pictures selected for transfer are identified by a  icon ( 6–7).

Slide Shows





Movies ( 37) appear as still images showing the movie's first frame. The camera will turn off automatically ( 75) if no operations are performed for 30 minutes during the show, even if **Loop** is selected.

Small Pic.

Create a small copy of the current picture. Highlight a size and press **OK**.

Option	Description
 640 × 480	Suited to television playback.
 320 × 240	Suited to display on web pages.
 160 × 120	Suitable for e-mail.



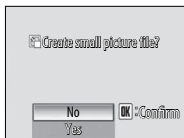

A confirmation dialog will be displayed. Highlight **Yes** and press the **OK** button to create a copy at the chosen size.

Small copies stored as JPEG files with a compression ratio of 1:16 (see page 89 for more information). During playback, copies are indicated by a gray border; a , , or  icon is displayed when they are viewed full-frame ( 6–7).



Copy

Copy pictures between internal memory and a memory card. This option is only available when a memory card is inserted.

Option	Description
 	Copy pictures from internal memory to memory card.
 	Copy pictures from memory card to internal memory.

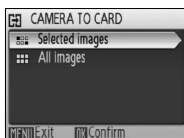

Selecting either of the above options displays the menu shown at right. Choose **Selected images** to select the pictures that will be copied ( 67) or **All images** to copy all pictures.











A confirmation dialog will be displayed. Highlight **Yes** and press the **OK** button to copy the images.



















Copy

Voice memos ( 44) will be copied with the associated picture, but voice recordings ( 38) will not. See “Copying Voice Recordings” for information on copying voice recordings ( 40). The camera may be unable to copy pictures that were created with another make of camera or that have been modified on a computer. See page 89 for more information on how copies are stored.

Basic Camera Setup: The Setup Menu

To display the setup menu, select **SET UP** or  from the shooting ( 61), playback ( 67), scene ( 26), movie ( 36), one-touch portrait ( 25), or voice recording menus ( 39). See page 17 for more on using the menus. Settings remain in effect until reset ( 76).

Option	Description	
 Menus	Choose how menus are displayed.	70
 Quick startup	Enable or disable welcome screen and start-up sound.	70
 Welcome screen	Select screen displayed when camera is turned on.	71
 Date	Set clock and choose home and destination time zones.	71
 Monitor settings	Adjust monitor brightness and choose display style.	73
 Date imprint	Imprint date or birthday counter on pictures.	74
 AF assist	Enable or disable AF assist illumination.	75
 Sound settings	Adjust sound and volume settings.	75
 Blur warning	Turn blur warning on or off.	75
 Auto off	Choose when monitor will turn off to save power.	75
 Format memory/ Format card	Format internal memory or memory card.	76
 Language	Choose language for camera menus and messages.	76
 Interface	Adjust settings for connection to television or computer.	76
 Reset all	Restore camera settings to default values.	76
 Firmware version	Display camera firmware version.	76

Menus

Choose how menus are displayed.



Text



Icon

Quick Startup

Choose **On** to disable the welcome screen ( 71) and start-up sound. The camera will be ready for shooting as soon as it is turned on.

Default Settings

See the Appendix for information on setup menu defaults ( 87).

Welcome Screen

Choose the welcome screen displayed when the camera is turned on. This option is only available when **Off** is selected for **Quick Startup**.

Option	Description
Nikon	COOLPIX logo displayed at start-up.
Animation	Animation displayed at start-up.
Select an image	Select picture from internal memory or memory card. Copy of selected image is created for use in welcome screen and remains when original is deleted or memory card is removed.

Date

Set the camera clock and choose home and travel destination time zones.

Option	Description
Date	Set camera clock to current date and time (see below).
Time zone	Choose home (🏠) or travel destination (🗺️) time zone (🕒 90); turn daylight saving time on or off.

Selecting **Date** displays the menu shown in Step 1. Follow the steps below to set the camera clock to the current date and time.

1

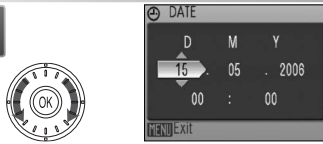

Edit **Day** (order of **Day, Month,** and **Year** may differ).

2

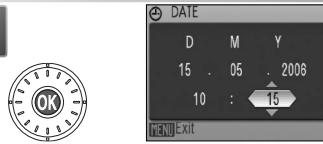

Select **Month**. Repeat steps 1–2 to edit **Month, Year, hour, and minute**.

3



Select **D M Y**.

4













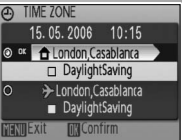

Choose date display order. Press **OK** to return to setup menu.

The Clock Battery

The clock battery charges when the main battery is installed or an AC adapter is connected, and can provide several days of backup power after about 10 hours of charging.

Selecting **Time zone** from the **Date** menu displays the dialog shown in Step 1. Follow the steps below to set the clock to the time in a new time zone.

<p>1</p>  <p>Highlight .</p>	 <p>TIME ZONE 15. 05. 2008 10:15 London, Casablanca DaylightSaving London, Casablanca DaylightSaving MENU Exit Confirm</p>	<p>2</p>  <p>Set clock to time in travel time zone.</p>	 <p>TIME ZONE 15. 05. 2008 10:15 London, Casablanca DaylightSaving London, Casablanca DaylightSaving MENU Exit Confirm</p>
<p>3</p>  <p>Display map of world time zones.</p>	 <p>NEW CITY TIME ZONE London, Casablanca MENU Back Confirm</p>	<p>4</p>  <p>Highlight travel destination time zone.</p>	 <p>NEW CITY TIME ZONE Hawaii, Tahiti MENU Back Confirm</p>
<p>5</p> 	 <p>TIME ZONE 15. 05. 2008 00:18 London, Casablanca DaylightSaving Hawaii, Tahiti DaylightSaving MENU Exit Confirm</p>	<p>Set clock to time in new time zone.  is displayed when camera is in shooting mode. To reset clock to home time zone, select  in time zone menu (Step 1). To turn daylight saving time in selected zone on or off, highlight DaylightSaving and press OK. Clock will automatically be advanced one hour. Press MENU button to exit to shooting or playback.</p>	

To change the home time zone, select  in Step 1 and follow Steps 2–5.







Monitor Settings

The following options are available:

Option	Description
Photo info	Choose information displayed in monitor.
Brightness	Choose from five settings for monitor brightness (default is 4).

Photo Info

The following display options are available:

Option	Description	Display	
		Shooting mode	Playback mode
Show info	Indicators are displayed in monitor (6–7).		
Auto info	Indicators are displayed for 5 s.		
Hide info	Indicators are not displayed in monitor.		
Framing grid	Indicators are displayed in monitor. In  mode, framing grid is displayed to help frame pictures; other indicators are displayed for 5 s.		

DATE Date Imprint

Imprint date information on pictures as they are taken.

Option	Description
Off	Time and date do not appear on pictures.
Date	Date or date and time are imprinted on pictures taken while this option is in effect.
Date and time	
Date counter	Time stamp shows number of days between date of shooting and selected date (see below).

At settings other than **Off**, the option selected is indicated by an icon in the monitor during shooting (6–7).

DATE Date Counter

Pictures taken while this option is in effect are imprinted with the number of days remaining until or the number of days elapsed since a specified date. Use it to track the growth of a child or count down the days until a birthday or wedding.

Press **OK** button to view stored dates

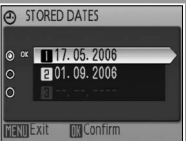
Stored dates	Up to three dates can be stored. To set, highlight, press rotary multi-selector to right, and enter date (71). To select, highlight and press OK button.	
Display options	Highlight Number of days , Years and days , or Yrs, mnths, days and press OK button.	



Press **OK** button to view display options

Sample date counter time stamps are shown below.



Future date (days remaining)



Past date (days elapsed)

DATE Date Imprint

The date is recorded in the order selected in the DATE menu (71). Date imprint can not be used to print date information on existing pictures. See page 55 for a comparison of date imprint and **Print set > Date**.

Data imprinted at an **Image mode** setting of **TV screen (640)** may be difficult to read. Choose **PC screen (1024)** or larger when using date imprint.

AF Assist

If **Auto** is selected, AF-assist illumination will be used to assist the focus operation when the subject is poorly lit (AF-assist illumination is unavailable in some modes;  84). Choose **Off** to disable AF-assist illumination (note that the camera may be unable to focus if lighting is poor).

Sound Settings

Adjust the following sound settings:

Option	Description
Button sound	When On is selected, beep will sound once when operations are completed successfully, three times when error is detected.
Shutter sound	Choose sound played when shutter is released (note that shutter sound may not always play;  84). Choose Off to disable shutter sound.
Volume	Choose volume from Loud , Normal , and Off .

Blur Warning

Choose whether or not the blur warning is displayed ( 21). Note that the warning may not always be displayed ( 84).

Auto Off

Choose the time before the monitor turns off automatically to save power from 30 seconds, 1 minute (the default setting), 5 minutes, or 30 minutes. Regardless of the option chosen, the monitor will remain on for 3 minutes when menus are displayed, and for 30 minutes when **Loop** is selected during Pictmotion or slide show playback or the camera is powered by the supplied AC adapter. While the monitor is off, the power-on lamp will blink. The camera will turn off automatically if no operations are performed for another three minutes.

Format Memory/ **Format Card**

If no memory card is inserted, this option is named **Format memory** and formats internal memory. Otherwise it is named **Format card** and formats the memory card for use in the camera. *Note that formatting permanently deletes all pictures and other data.* Be sure to make copies as required before formatting.

Two format options are available when a memory card is inserted: **Quick format** (formats only areas of the card on which data are stored) and **Format** (formats entire card). **Format** is not available when batteries are low.

Format

Do not turn the camera off, disconnect the AC adapter, or remove the battery or memory card during formatting. Use the **Format** option to format memory cards before first use and reformat them regularly thereafter. Without regular formatting, performance will drop with use.





Language

Choose a language for camera menus and messages from the following options:

Čeština	Czech	Italiano	Italian	Svenska	Swedish
Dansk	Danish	Nederlands	Dutch	中文简体	Simplified Chinese
Deutsch	German	Norsk	Norwegian	中文繁體	Traditional Chinese
English	English	Polski	Polish	日本語	Japanese
Español	Spanish	Português	Portuguese	한국어	Korean
Français	French	Русский	Russian	ภาษาไทย	Thai
Indonesia	Indonesian	Suomi	Finnish		

Interface

Adjust settings for connection to a computer or video device.

Option	Description
USB	Select USB option for connection to computer ( 54) or printer ( 56, 60).
Video mode	Choose from NTSC and PAL ( 52).
Auto transfer	Choose On to mark all new pictures for transfer to computer ( 53).

Reset all

Select **Reset** to restore camera settings to their default values ( 87).

Firmware Version

View the current camera firmware version.

Optional Accessories

At the time of writing, the following optional accessories and replacement items were available for this camera. Contact your local retailer or Nikon representative for details.

Rechargeable battery	Rechargeable EN-EL8 Li-ion batteries
Battery charger	MH-62 battery charger
AC adapter	EH-64 AC adapter
Cradle	MV-14 COOL-STATION
ImageLink-compatible printer adapter	PV-10 Dock Insert
USB cable	UC-E10 USB cable
A/V cable	EG-E5000 audio/video cable
Water-resistant case	FJ-CP1 Field Jacket (water resistant to 3 m/9ft. 10in.)

Approved Memory Cards

The following memory cards have been tested and approved for use in the COOLPIX S5:

Panasonic	64 MB, 128 MB, 256 MB, 256 MB*, 512 MB, 512 MB*, 1 GB, 1 GB*
SanDisk	64 MB, 128 MB, 256 MB, 256 MB*, 512 MB, 512 MB*, 1 GB, 1 GB*
Toshiba	64 MB, 128 MB, 128 MB*, 256 MB, 256 MB*, 512 MB, 512 MB*, 1 GB

* High speed (10 MB/s)

Other cards have not been tested. For more details on the above cards, please contact the manufacturer.

Memory Cards

- Use only Secure Digital (SD) memory cards.
- Format memory cards before first use (76).
- Do not eject the memory card, turn the camera off, remove the batteries, or disconnect the AC adapter during formatting or while data are being written to or deleted from the card. Failure to observe this precaution could result in loss of data or damage to the camera or card.
- Do not disassemble or modify.
- Do not drop, bend, or expose to water or strong physical shocks.
- Do not touch the metal terminals with your fingers or metal objects.
- Do not affix labels or stickers to the memory card.
- Do not leave in direct sunlight, closed vehicles, or areas exposed to high temperatures.
- Do not expose to high levels of humidity or to corrosive gas.

Caring for the Camera

To ensure continued enjoyment of this Nikon product, observe the following precautions when storing or using the device.

✓ Handle the lens and all moving parts with care

The lens, monitor, and battery-chamber/memory card slot and lens covers are easily damaged. Do not use force. Force applied to the lens cover could cause malfunction or damage the lens. Should the monitor break, care should be taken to avoid injury due to broken glass and to prevent the liquid crystal from the display touching the skin or entering the eyes or mouth.

✓ Do not point the lens at strong light sources for extended periods

Avoid framing the sun or other strong light sources for extended periods when using or storing the camera. Intense light may cause deterioration in the image sensor, producing a white blur effect in photographs.

✓ Turn the product off before removing or disconnecting the power source

Do not unplug the product or remove the battery while the product is on, or while images are being recorded or deleted. Forcibly cutting power could result in loss of data or in damage to product memory or circuitry. To prevent an accidental interruption of power, do not move the product while the AC adapter is connected.

✓ Keep dry

The device will be damaged if immersed in water or subjected to high levels of moisture.

✍ Notes on the Monitor

- The monitor may contain a few pixels that are always lit or that do not light. This is a characteristic common to all TFT LCD displays, and does not indicate a malfunction. Images recorded using the product will not be affected.
- When you frame bright subjects, vertical comet-like streaks that whiten toward either end may appear in the display. This phenomenon, known as “smear,” does not appear in the final photograph and does not indicate a malfunction. Some smear may appear in movies.
- Images in the monitor may be difficult to see in a bright light.
- The monitor is lit by an LED backlight. Should the monitor begin to dim or flicker, contact your Nikon service representative.

✓ Do not drop

The product may malfunction if subjected to strong shocks or vibration.

✓ Keep away from strong magnetic fields

Do not use or store this device in the vicinity of equipment that generates strong electromagnetic radiation or magnetic fields. Strong static charges or the magnetic fields produced by equipment such as radio transmitters could interfere with the monitor, damage data stored on the memory card, or affect the product's internal circuitry.

✓ Avoid sudden changes in temperature

Sudden changes in temperature, such as occur when entering or leaving a heated building on a cold day, can cause condensation inside the device. To prevent condensation, place the device in a carrying case or a plastic bag before exposing it to sudden changes in temperature.

✓ The AF-Assist Illuminator LED

The light-emitting diode (LED;  2, 21) used in the AF-assist illuminator conforms to the following IEC standard:

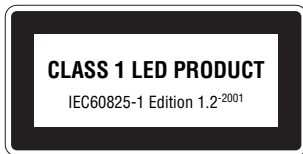

Cleaning

Lens	Avoid touching glass parts with your fingers. Remove dust or lint with a <i>blower</i> (typically a small device with a rubber bulb attached to one end that is pumped to produce a stream of air out the other). To remove fingerprints or other stains that can not be removed with a blower, wipe the lens with a soft cloth, using a spiral motion that starts in the center of the lens and works out to the edges. If this fails, clean the lens using a cloth lightly dampened with commercial lens cleaner.
Monitor	Remove dust or lint with a blower. To remove fingerprints and other stains, clean the monitor with a soft, dry cloth, being careful not to apply pressure.
Body	Use a blower to remove dust, dirt, or sand then wipe gently with a soft, dry cloth. After using the camera at the beach or seaside, wipe off any sand or salt with a dry cloth lightly dampened with fresh water, then dry thoroughly. Note that foreign matter inside the camera could cause damage not covered under warranty.

Do not use alcohol, thinner, or other volatile chemicals.

Batteries

- Check the battery level when taking the camera out and charge the battery if necessary (ⓘ 11). Do not continue charging once the battery is fully charged, as this will result in reduced battery performance. If possible, carry a fully-charged spare battery when taking pictures on important occasions.
- Do not use the battery at ambient temperatures below 0°C (32°F) or above 40°C (104°F). During charging, the temperature should be in the vicinity of 5–35°C (41–95°F). Note that the battery may become hot during use; wait for the battery to cool before charging. Failure to observe these precautions could damage the battery, impair its performance, or prevent it from charging normally.
- On cold days, the capacity of batteries tends to decrease. Be sure that the battery is fully charged before heading outside to take pictures in cold weather. Keep spare batteries in a warm place and exchange as necessary. Once warmed, a cold battery may recover some of its charge.
- Dirt on the battery terminals can prevent the camera from functioning.
- When the battery is not in use, remove it from the camera or battery charger and replace the terminal cover. The camera and battery charger draw minute amounts of current even when off; if left in place, the battery could be drained to the point that it no longer functions. Turning the camera on or off while the battery is exhausted can result in reduced battery life. If the battery will not be used for an extended period, store it in a cool (15°C–25°C/59°F–77°F), dry place. Recharge it at least once a year and run it flat before returning it to storage.
- Replace the battery when it no longer holds a charge. Used batteries are a valuable resource. Please recycle used batteries in accordance with local regulations.

Storage









Turn the camera off when not in use. Check that the power-on lamp is off before putting the camera away and remove the batteries if the camera will not be used for an extended period. Do not store the camera with naphtha or camphor moth balls or in locations that:









- are next to equipment that produces strong electromagnetic fields, such as televisions or radios
- are exposed to temperatures below -10°C (14°F) or above 50°C (122°F)
- are poorly ventilated or subject to humidities of over 60%



To prevent mold or mildew, take the camera out of storage at least once a month. Turn the camera on and release the shutter a few times before putting the camera away again.

Error Messages

The following table lists the error messages and other warnings that appear in the monitor and how to deal with them.

Display	Problem	Solution	
 (blinks)	Clock not set.	Set clock.	71
	Battery running low.	Prepare to charge or change battery.	10–11
WARNING!! BATTERY EXHAUSTED	Battery exhausted.	Charge or change battery.	10–11
 (● blinks red)	Camera cannot focus.	Use focus lock to focus on another subject at same distance, then recompose picture.	66
 (blinks)	Slow shutter speed. Pictures may be blurred.	Use flash, or steady camera using tripod, by placing camera on level surface, or by holding camera in both hands with elbows against torso.	18, 20
WARNING!! PLEASE WAIT FOR CAMERA TO FINISH RECORDING 	Camera cannot perform other operations until recording is complete.	Message clears from display automatically when recording is complete.	—
MEMORY CARD IS WRITE PROTECTED	Write-protect switch is in "lock" position.	Slide write-protect to "write" position.	13
NO CARD PRESENT	No memory card inserted in Pictmotion mode.	Insert memory card.	12
THIS CARD CANNOT BE USED 	Error accessing memory card.	<ul style="list-style-type: none"> • Use approved card. • Check that connectors are clean. • Confirm that memory card is correctly inserted. 	77
WARNING!! THIS CARD CANNOT BE READ 			12

Display	Problem	Solution	
CARD IS NOT FORMATTED  Format No	Memory card has not been formatted for use in camera.	Highlight FORMAT and press  button to format card, or turn camera off and replace card.	12
IMAGE CANNOT BE SAVED  or 	Error occurred while recording picture.	Format internal memory or memory card.	76
	Camera has run out of file numbers.	<ul style="list-style-type: none"> Insert new memory card. Select Reset all after either inserting new memory card or formatting internal memory or memory card. 	12 76
	Cannot create cropped, D-lighting, or small copy.	Select picture that supports crop, D-lighting, or small picture.	89
	Picture cannot be used for welcome screen.	Choose picture 640×480 pixels or larger.	—
	Cannot copy picture.	Delete pictures from destination.	68
Image has already been modified. D-Lighting cannot be used.	Original does not support D-lighting.	D-lighting can not be used with copies.	89
SOUND FILE CANNOT BE SAVED  or 	Camera has run out of file numbers.	Select Reset all after either inserting new memory card or formatting internal memory or memory card.	76
CANNOT RECORD MOVIE	Time out error while recording movie.	Choose memory card with faster write speed.	77
OUT OF MEMORY  or 	Memory card is full.	<ul style="list-style-type: none"> Choose smaller image size. Delete pictures or voice recordings. Insert new memory card. Remove memory card and use internal memory. 	61 40, 68 12 13
CARD CONTAINS NO IMAGES	No pictures available for playback.		—
NO SOUND FILE	No sound file available for playback.		—
FILE CONTAINS NO IMAGE DATA	File not created with COOLPIX S5.	View file on computer or other device.	—
THIS FILE CANNOT BE PLAYED BACK.			
ALL IMAGES ARE HIDDEN	No pictures available for welcome screen or slide show.		—
PICTMOTION CANNOT BE CREATED	No pictures selected for Pictmotion movie.	Select pictures.	49
PICTMOTION CANNOT BE PLAYED BACK	Pictmotion files have been deleted or moved.	Delete affected Pictmotion movie.	51
THIS IMAGE CANNOT BE DELETED	Picture is protected.	Remove protection.	68



Display	Problem	Solution	
NEW CITY IS IN THE CURRENT TIME ZONE	Destination in same time zone as home.	No need to change time zones if destination is in same time zone as home.	72
INITIALIZING LENS CANNOT FOCUS 	Camera cannot focus.	Wait until message has cleared from display and camera has zoomed all the way out.	—
LENS ERROR	Lens error.	Turn camera off and then on again. If error persists, contact retailer or Nikon representative.	14
LENS COVER ERROR	Finger or other obstruction prevents lens cover from opening.	Turn camera off and remove obstruction.	2, 14
COMMUNICATIONS ERROR	USB cable disconnected during transfer or printing.	If PictureProject displays error, click OK to exit. Resume operation after turning camera off and reconnecting cable.	52–53, 56
	USB option incorrect.	Choose correct USB option.	54
	PictureProject did not start.	See the PictureProject reference manual (on CD) for more information.	—
NO IMAGES ARE MARKED FOR TRANSFER	No pictures selected for transfer.	Select pictures for transfer and try again.	68
TRANSFER ERROR	Transfer error.	<ul style="list-style-type: none"> • Check battery level. • Check that USB cable is connected. 	14 52–53
SYSTEM ERROR	Error has occurred in camera's internal circuitry.	Turn camera off, remove and reinsert batteries, and turn camera on. If error persists, contact retailer or Nikon representative.	10
PRINTER ERROR CHECK PRINTER STATUS	Printer error.	Check printer. To resume, highlight Resume (if available) and press  button.	—















Electronically Controlled Cameras





In extremely rare instances, unusual characters may appear in the monitor and the camera may stop functioning. In most cases, this phenomenon is caused by a strong external static charge. Turn the camera off, remove and replace the batteries, and then turn the camera on again. In the event of continued malfunction, contact your retailer or Nikon representative. Note that disconnecting the power source as described above may result in the loss of any data not recorded to internal memory or the memory card at the time the problem occurred. Data already recorded will not be affected.

Troubleshooting

If the camera fails to function as expected, check the list of common problems below before consulting your retailer or Nikon representative. Refer to the page numbers in the right-most column for more information.

Problem	Solution	
Camera turns off without warning	<ul style="list-style-type: none"> • Battery is low. • Camera has turned off automatically to save power. • Battery is cold. 	14 14 93
Monitor is blank	<ul style="list-style-type: none"> • Camera is off. • Battery is exhausted. • Standby mode: monitor turns on when controls are used. • Flash lamp blinks red: wait until flash has charged. • USB cable is connected. • A/V cable is connected. • Time lapse or interval timer photography in progress: monitor turns off automatically between shots 	14 14 14 20 53, 56 52 36, 64
No indicators appear in monitor	Hide info is selected for Photo info . Select Show info .	73
Monitor is hard to read	<ul style="list-style-type: none"> • Monitor has dimmed to save power: monitor brightens when controls are used. • Adjust monitor brightness. • Monitor is dirty: clean monitor. 	14 73 79
Camera clock is not correct	Check camera clock regularly against more accurate timepieces and reset as required.	71
Camera settings reset	Clock battery exhausted: recharge clock battery. Pictures recorded before clock has been set will have time stamp of "00.00.0000 00:00"; movies will be dated "01.01.2006 00:00."	71
No picture taken when shutter-release button is pressed	<ul style="list-style-type: none"> • Camera is in playback mode: press  button. • Menus are displayed: press  button. • Battery is exhausted. 	41 17 14
Camera can not focus using autofocus	<ul style="list-style-type: none"> • Subject is low in contrast, dominated by repeating geometric patterns, covers too small an area of the frame, or contains many fine details, objects of sharply differing brightness, or objects at different distances from the camera. Use focus lock to focus on another subject at same distance. • Off is selected for AF assist option in camera setup menu. • Focus error. Turn camera off and then on again. 	66 75 14
Pictures are blurred	<ul style="list-style-type: none"> • Use flash. • Use BSS. • Use tripod and self-timer. 	20 65 3, 22

Problem	Solution	
Pictures are too dark (underexposed)	<ul style="list-style-type: none"> Flash is off. Flash window is blocked. Subject is outside range of flash. Exposure compensation is too low. Subject is backlit: select  (scene mode) or use fill flash. 	20 18 20 25, 31, 63 20, 28
Pictures are too bright (overexposed)	Exposure compensation is too high.	25, 31, 63
Randomly-spaced bright pixels (“noise”) appear in image	Shutter speed too slow. Noise can be reduced by: <ul style="list-style-type: none"> Using flash Setting Sensitivity to 50 Choosing scene mode option with noise reduction 	20 65 28, 34
Pictures are smeared	Lens is dirty. Clean lens.	79
Colors are unnatural	White balance does not match light source.	62
Flash does not fire	Flash is off. Note that flash turns off automatically in  mode (Time lapse movie excepted) and some scene modes or when option other than Single or Intvl timer shooting is selected for Continuous or BSS is on.	20, 26, 35, 63, 65
AF-assist illuminator does not light	<ul style="list-style-type: none"> Off is selected for AF assist option in camera setup menu. AF assist illumination turns off automatically in  (POR-TRAIT excepted),  (NIGHT PORTRAIT excepted),  and  modes. 	75 26
Bright specks in pictures taken with flash	Flash is reflecting from particles in air. Turn flash off.	20
Blur warning is not displayed	<ul style="list-style-type: none"> Off is selected for Blur warning in camera setup menu. Blur warning is not displayed in self-timer, , , , , or  mode or when option other than Single is selected for Continuous or BSS is on. 	75 22, 26, 35, 63, 65
No sound when shutter is released	Sound is not played when Off selected for Sound settings > Shutter sound , BSS on, option other than Single selected for Continuous , or  or  mode is selected.	34, 35, 63, 65, 75
Optical zoom cannot be used	Optical zoom cannot be used while shooting movies.	35
Digital zoom cannot be used	Digital zoom is not available when Multi shot 16 is selected for Continuous .	63
Unexpected results when flash set to  (auto with red-eye reduction).	In-camera red-eye fix may, in very rare cases, be applied to areas not affected by red-eye. Set flash to  (auto) or  (fill-flash) and try again. Note that red-eye reduction is the default setting for one-touch portrait,  , and  modes.	20, 24, 33, 34
Image mode not available	Image mode cannot be adjusted when Multi shot 16 is selected for Continuous or “Sports composite” is selected in scene mode.	34, 63

Problem	Solution	
Date imprint not available	Camera clock has not been set.	71
Date not appearing on pictures	Date does not appear on movies or pictures taken using   (Sports composite excepted), Continuous , or BSS.	26, 35, 63, 65
Pictures cannot be played back	<ul style="list-style-type: none"> Time lapse or interval timer photography in progress: pictures can not be played back until recording is complete. File has been overwritten or renamed by computer or other make of camera. 	36, 64 —
Cannot zoom in on picture	Playback zoom cannot be used with movies, small pictures, or pictures that have been cropped to below 320 × 240.	37, 42, 69
Cannot record voice memo	Voice memos cannot be appended to movies.	37
Cannot use crop, D-lighting, or small picture options	These options cannot be used with movies and may not be available with pictures created with other cameras. Select picture that supports crop, D-lighting, or small picture.	89
Cannot create new Pictmotion movie	Camera may be unable to create Pictmotion movies using pictures recorded with other cameras. Other cameras may be unable to play Pictmotion movies created with COOLPIX S5.	48
Cannot mark pictures for transfer	No more than 999 pictures can be marked for transfer. Use PictureProject Transfer button to transfer pictures.	53
Transfer marking does not appear	Pictures were marked for transfer using another model of camera. Mark pictures for transfer using S5.	68
PictureProject does not start when camera is connected	<ul style="list-style-type: none"> Camera is off. Battery is exhausted. USB cable is not correctly connected. Appropriate USB option is not selected. Computer can not detect camera. See the PictureProject reference manual (on CD) for further information.	14 14 53 54 —
Cannot transfer pictures	 button can not be used to transfer pictures from internal memory when Mass Storage is selected for USB or if memory card is locked. Transfer pictures using PictureProject transfer button.	53, 54
Pictures not displayed on television	<ul style="list-style-type: none"> Choose correct video mode. USB cable is connected: disconnect USB cable 	52 8
Format card > Format option not available	Batteries are low.	14

Appendix

Operation Flowchart

The following flowchart illustrates basic camera operations.

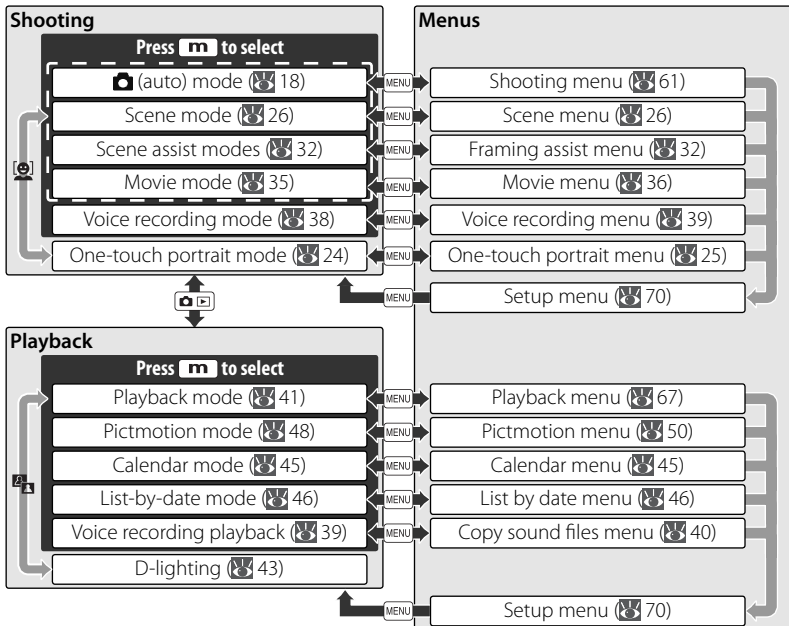

Supported Standards

- **DCF:** Design Rule for Camera File System (DCF) is standard widely used in the digital camera industry to ensure compatibility among different makes of camera.
- **DPOF:** Digital Print Order Format (DPOF) is an industry-wide standard that allows pictures to be printed from print orders stored on the memory card.
- **Exif version 2.2:** This camera supports Exif (Exchangeable Image File Format for Digital Still Cameras) version 2.2, a standard that allows information stored with photographs to be used for optimal color reproduction when images are output on Exif-compliant printers.
- **PictBridge:** A standard developed by in cooperation with the digital camera and printer industries, allowing photographs to be output directly to a printer without connecting the camera to a computer.
- **ImageLink:** The ImageLink standard allows pictures taken with a digital camera to be printed directly on a household printer, without using a computer. The camera can be connected directly to any ImageLink-compatible printer for one-touch picture printing.

Defaults (🔗 61, 67, 70, 76)

Choosing **Reset** for **Reset all** restores the following default settings:

Option	Default
Shooting mode (🔗 18–25)	
Flash mode	Auto
Self timer	Off
Macro close-up	Off
One-touch portrait	
Exposure compensation	0
Portrait effect	Normal
Scene mode (🔗 26–34)	
mode framing assist	PORTRAIT
mode framing assist	LANDSCAPE
mode framing assist	SPORTS
mode framing assist	NIGHT PORTRAIT
Exposure compensation	0
Movie menu (🔗 36–37)	
Movie options	Small size 320
Set interval time	30 s
Auto-focus mode	Single AF
Electronic VR	Off
Pictmotion settings (🔗 50)	
Music	Pachelbel Kanon
Style	Motion
Playback order	Random
Fit to length	Repeat photos
Auto select	10 pictures
Shooting menu (🔗 61–66)	
Image mode	Normal (2816)
White balance	Auto
Exp. +/-	0
Continuous	Single
Interval timer	30 s

Option	Default
Shooting menu (continued)	
BSS	Off
Exposure BSS	Highlight BSS
Sensitivity	Auto
Color options	Standard color
AF-area mode	Center
Playback menu (🔗 67–69)	
Slide show	
Frame intvl	3 s
Setup menu (🔗 70–76)	
Menus	
Quick startup	On
Welcome screen	Animation
Monitor settings	
Photo info	Show info
Brightness	4
Date imprint	Off
AF assist	Auto
Sound settings	
Button sound	On
Shutter sound	1
Volume	Normal
Blur warning	On
Auto off	1 min.
Auto transfer	On
Miscellaneous	
Sound quality (🔗 39)	High
Paper size (🔗 57, 58)	Default

Choosing **Reset** also clears the current file number (🔗 89) from memory. Numbering will continue from the lowest number available (to reset file numbering to 0001, delete all pictures before selecting **Reset**). All other settings are unaffected, including **Date** (🔗 71), **Date counter** (🔗 74), **Language** (🔗 76), **USB** (🔗 76), and **Video mode** (🔗 76).

Image Mode (📷 61), Movie Options (🎥 36), and Sound Quality (🔊 39)

The following table lists the number of pictures, maximum length per movie, or maximum total voice recording length that can be recorded to internal memory or a 256 MB memory card, together with the size of still pictures printed at 300 dpi.

	Setting	Internal memory (21 MB)	256 MB memory card	Print size (cm / in.)
Image mode	High (2816*)	7	85	24 × 18/9½ × 7
	Normal (2816)	14	165	24 × 18/9½ × 7
	Normal (2048)	26	305	17 × 13/7 × 5
	PC screen (1024)	90	1045	9 × 7/3½ × 2½
	TV screen (640)	193	2245	5 × 4/2 × 1½
Movie options	TV movie 640*	19s	3 min. 40s	—
	Small size 320*	38s	7 min. 20s	—
	Small size 320	1 min. 14s	14 min. 30s	—
	Pictmotion 320	1 min.	1 min.	—
	Smaller size 160	4 min. 7s	48 min. 5s	—
	Time lapse movie*	225 frames	1800 frames	—
Sound quality	Normal	46 min. 8s	5 hr.	—
	High	16 min. 43s	3 hr. 15 min. 55s	—

* All figures are approximate. Actual capacity varies with make of memory card and, in the case of JPEG images, with the type of scene recorded. If memory remains for more than 9999 pictures, exposure count display will show 9999.

Restrictions on Camera Settings (📷 61)





Restrictions apply to the following settings in 📷 mode:

Flash mode	Flash turns off at Continuous settings of Continuous or Multi-shot 16 or when BSS is on. Original mode is restored when Single or Intvl timer shoot-ing is selected or BSS is turned off.
Self timer	If self-timer is on, only one shot will be taken when shutter is released, regardless of settings chosen for Continuous and BSS . Original Continuous and BSS settings are restored when picture is taken or self-timer is turned off.
Continuous	Selecting Continuous or Multi-shot 16 turns BSS off. Original BSS setting is not restored when Single is selected.
BSS	Continuous is set to Single when BSS is on. Original setting is not restored when BSS is turned off.
White balance	White balance is set to Auto and can not be adjusted when Black and white , Sepia , or Cyanotype is selected for Color options . Original white balance is restored when Standard color or Vivid color is selected.

Image File and Folder Names

Pictures, movies, and voice memos are assigned file names with three parts: a four letter identifier, a four-digit file number assigned automatically by the camera in ascending order, and a three-letter extension (e.g., "DSCN0001.JPG").





Originals	Identifier	Extension	Copies	Identifier	Extension
Still picture	DSCN	.JPG	Cropped copy	RSCN	.JPG
Movie	DSCN	.MOV	Small copy	SSCN	.JPG
Time-lapse movie	INTN	.MOV	D-lighting copy	FSCN	.JPG
Voice recording	DSCN	.WAV			
Voice memo	Same as picture	.WAV			

Pictures and sound files are stored in folders named with a three-digit folder number followed by a five-character identifier: "P_" plus a three-digit sequence number for pictures taken using panorama assist (e.g., "101P_001";  29–30), "INTVL" for interval timer photography (e.g., "101INTVL";  64), "SOUND" or "SOUNE" for voice recordings (e.g., "101SOUND";  38), and "NIKON" for all other pictures (e.g., "100NIKON"). Folders can hold up to 200 pictures; if a picture is taken when the current folder contains 200 pictures, a new folder will be created by adding one to the current folder number. If a picture is taken when the current folder is numbered 999 and contains 200 pictures or a picture numbered 9999, no further pictures can be taken until the medium is formatted ( 76) or a new memory card inserted.

Files copied using **Copy > Selected images** or COPY SOUND FILES > **Selected files** are copied to the current folder, where they are assigned new file numbers in ascending order starting from the largest file number in memory. **Copy > All images** and COPY SOUND FILES > **Copy all files** copy all folders from the source device; file names do not change but new folder numbers are assigned in ascending order starting from the largest folder number on the destination device ( 40, 69).

Pictmotion movies ( 48) are stored under the "NKSS" folder in folders named with a three-digit folder number followed by "PRJCT" (e.g., "101PRJCT"). Each folder contains the picture and sound files for a single Pictmotion movie.

Copies (42, 43, 69)

Copies created using crop ( 42), D-Lighting ( 43), and small picture ( 69) have the same transfer marking as the original but are not marked for printing or protection. Copies created using **Copy** ( 69) have the same protection marking as the original but are not marked for printing or transfer. The crop and small picture options can not be used with copies created with crop or small picture; D-lighting is not available with copies created with crop, D-lighting, or small picture.

Time Zones (🕒 71–72)

The camera supports the time zones listed below. Increments of less than one hour are not supported; when travelling to or from destinations at half- or quarter-hour increments from Greenwich Mean Time (GMT), such as Afghanistan, Central Australia, India, Iran, Nepal, or Newfoundland, set the camera clock to local time (🕒 71–72).

GMT +/-	Location	GMT +/-	Location
-11	Midway, Samoa	+1	Madrid, Paris, Berlin
-10	Hawaii, Tahiti	+2	Athens, Helsinki
-9	Alaska, Anchorage	+3	Moscow, Nairobi
-8	PST (PDT): Los Angeles, Seattle, Vancouver	+4	Abu Dhabi, Dubai
-7	MST (MDT): Denver, Phoenix, La Paz	+5	Islamabad, Karachi
-6	CST (CDT): Chicago, Houston, Mexico City	+6	Colombo, Dhaka
-5	EST (EDT): New York, Toronto, Lima	+7	Bangkok, Jakarta
-4	Caracas, Manaus	+8	Beijing, Hong Kong (HK), Singapore
-3	Buenos Aires, São Paulo	+9	Tokyo, Seoul
-2	Fernando de Noronha	+10	Sydney, Guam
-1	Azores	+11	New Caledonia
±0	London, Casablanca	+12	Auckland, Fiji

Specifications

Nikon COOLPIX S5 Digital Camera

Type	Compact digital camera
Effective pixels	6.0 million
CCD	1½s-in. CCD; total pixels: 6.18 million
Image size (pixels)	• 2,816 × 2,112 (2816★, 2816) • 1,024 × 768 (1024) • 2,048 × 1,536 (2048) • 640 × 480 (640)
Lens	3 × Zoom-Nikkor ED Lens
Focal length	5.8–17.4 mm (35 mm [135] picture angle equivalent: approx. 35–105 mm)
f/-number	f/3.0–f/5.4
Construction	12 elements in 10 groups
Digital zoom	Up to 4 × (35 mm [135] picture angle equivalent: 420 mm)
Autofocus (AF)	Contrast-detect AF with AF-assist illumination
Focus range (from lens)	30 cm (1 ft.)–∞ Macro mode: 4 cm (1.6 in.)–∞ (middle zoom position)
Focus-area selection	Center; manual with 99 focus areas
AF-assist illumination	Class 1 LED product (IEC 60825-1 Edition 1.2 ²⁰⁰¹); max. output: 1,500 μW
Monitor	2.5 in., 230,000-dot, wide viewing-angle low-temperature polysilicon TFT LCD with 5-level brightness adjustment
Approximate frame coverage	Shooting mode: 97% horizontal and 97% vertical Playback: 100% horizontal and 100% vertical
Storage	
Media	Internal memory (approx. 21 MB); SD (Secure Digital) memory cards
File system	DCF, Exif 2.2, and DPOF compliant
File formats	Compressed: JPEG-baseline-compliant Movies: QuickTime Sound files: WAV
Exposure	
Metering	256-segment matrix, center-weighted, spot, spot AF area
Exposure control	Programmed auto exposure with exposure compensation (–2.0–+2.0 EV in steps of ½ EV)
Range	W: +1.2–+16.1 EV T: +2.9–+17.8 EV
Shutter	Mechanical and charge-coupled electronic shutter
Speed	2–1/500 s
Aperture	Electronically-controlled ND filter selection
Range	f/3.0 and f/8.5 (W)
ISO sensitivity	50, 100, 200, 400 (ISO equivalent); Auto (auto gain to ISO 200 equivalent)
Self-timer	Can be selected from approximately 10 and 3 seconds duration

Built-in flash	
Range (approx.)	W: 0.3–2.6 m/1 ft.–8 ft. 6 in. T: 0.3–1.4 m/1 ft–4 ft. 7 in.
Sync method	Sensor flash system
I/O terminals	Multi connector (supports ImageLink)
Interface	USB
Video output	Can be selected from NTSC and PAL
Supported languages	Chinese (Simplified and Traditional), Czech, Danish, Dutch, English, Finnish, French, German, Indonesian, Italian, Japanese, Korean, Polish, Portuguese, Norwegian, Russian, Spanish, Swedish, Thai
Power sources	<ul style="list-style-type: none"> • One EN-EL8 rechargeable lithium-ion battery (supplied) • EH-64 AC adapter (supplied)
Battery life	Approx. 210 shots (EN-EL8)*
Dimensions	Approx. 93×59×20 mm/3.7×2.3×0.8 in. (W×H×D, excluding projections)
Weight	Approx. 135 g (4.8 oz.) without battery or memory card
Operating environment	
Temperature	0–40 °C (32–104 °F)
Humidity	Less than 85% (no condensation)

* Based on Camera and Imaging Products Association (CIPA) standard for measuring life of camera batteries. Measured at 25 °C (77 °F); zoom adjusted with each shot, flash fired with every other shot, image mode set to NORMAL.

Unless otherwise stated, all figures are for a camera with fully-charged EN-EL8 battery operated at an ambient temperature of 25 °C (77 °F).

MV-14 COOL-STATION

Supported cameras	COOLPIX S5 digital cameras
I/O terminals	DC in, USB, audio-video out, camera connector
Interface	USB
Operating temperature	0–40 °C (32–104 °F)
Dimensions	Approx. 103.5×28×50.5 mm/4.1×1.1×2.0 in. (W×H×D, excluding projections)
Weight	Approx. 50 g (1.8 oz.)

PV-10 Dock Insert

Dimensions	Approx. 135.5×22.5×63 mm/5.3×0.9×2.5 in. (W×H×D, excluding projections)
Weight	Approx. 33 g (1.2 oz.)

Specifications

Nikon will not be held liable for any errors this manual may contain. The appearance of this product and its specifications are subject to change without notice.

EH-64 AC Adapter



















Rated input	100–240V AC, 50/60 Hz, 0.18–0.1 A
Rated capacity	18–22 VA
Rated output	DC 4.8 V/1.5 A
Operating temperature	0–40 °C (32–104 °F)
Dimensions	Approx. 41 × 23.5 × 79 mm/1.6 × 0.9 × 3.1 in. (W × H × D, excluding projections)
Length of cord	Approx. 1.7 m (5 ft. 7 in.)
Weight	Approx. 110 g (3.9 oz), excluding power cable

EN-EL8 Rechargeable Li-ion Battery

Type	Rechargeable lithium-ion battery
Rated capacity	3.7 V/730 mAh
Operating temperature	0–40 °C (32–104 °F)
Dimensions	Approx. 35 × 47 × 5 mm/1.4 × 1.9 × 0.2 in. (W × H × D, excluding projections)
Weight	Approx. 17 g (0.6 oz.), excluding terminal cover

Index

Symbols

-  (auto) mode, 18
-  (calendar) mode, 45
-  (delete) button, 19, 41
-  (D-lighting) button, 2, 43
-  (list-by-date) mode, 46
-  (MENU) button, 3, 17
-  (mode) button, 3, 5, 17
-  (movie) mode, 35
-  (One-touch portrait) button, 2, 24
-  (Pictmotion) mode, 48
-  (playback) mode, 41
-     see scene assist modes
-  (shooting/playback) button, 3, 19, 41
-  (voice recording) mode, 38
-  (voice recording) playback mode, 39
-  (wait) icon, 16, 80

A

- Accessories, 77
- AE-L, 29
- AF , see Focus, indicator
- Autofocus, see Focus
- AF area mode, 66
- AF Assist, 75
- Auto-focus mode, 37
- Auto off, 75
- Auto transfer, see Interface
- A/V cable, 8, 52

B

- Backlit subjects, 20, 28
- Batteries, 10–11
- Battery level indicator, 6–7, 14
- Best Shot Selector, 65
- Black-and-white, 66
- Blur, 21, 75
- Blur warning, 75
- Brightness, see Monitor settings
- BSS, see Best Shot Selector
- Burst shooting, see Continuous; Scene assist, Sports ()
- Button sound, see Sound settings

C

- Calendar playback, 45

- Clock, see Date
- Close-ups, 23, 28
- Color options, 66
- Computer, 52
 - copying pictures to, 52
- Continuous, 63
- Copies, 42, 43, 69. See also Copy (playback menu); Cropping pictures; D-lighting; Small pic.
- Copy (playback menu), 69
- Cropping pictures, 42
- Cyanotype, 66

D

- Date, 71
- Date and time, see Date printing, 55, 59, 74
- Date counter, see Date imprint
- Date imprint, 74
- Daylight saving time, see Date
- DCF, see Design rule for Camera File system
- Default settings, 87
 - restoring, see Reset all
- Delete, 68
- Deleting pictures, 19, 41, 68
 - in full-frame playback, 19, 41
 - selected pictures, 68
- Design rule for Camera File system, 86
- Digital Print Order Format, 58–59, 86
- Direct Print, see PictBridge
- D-lighting, 43
- Dock insert, 60
- DPOF, see Digital Print Order Format

E

- Electronic VR, 37
- E-mail, 61, 69
- Error messages, 80–82
- Exif 2.2, 86
- Exif Print, see Exif 2.2
- Exp. +/-, 25, 31, 63
- Exposure compensation, 25, 31, 63
 - scene mode, 31
 - shooting mode, 63
- Extension, 89

F

- Field jacket, see Accessories
- Fill flash, 20
- Firmware, 76
- Firmware version, 76
- Flash, 20
 - mode, 20
 - Focus, 16, 66
 - area, 16, 66
 - face-priority, 24
 - indicator, 16
 - lock, 66
 - mode, 37, 66
- Format, see Format card
- Format card, 76
- Format memory, 76
- Formatting, 12, 76
 - internal memory, see Format memory
 - memory cards, see Format card
- Framing, 16, 18, 24, 32
 - guides, 32
- Full-time AF, see Focus, mode

H

- Help, 17

I

- ImageLink, 60, 86
- Image mode, 61
- Image size, see Image mode
- Indicator lamp, 11, 16, 36, 38, 64
- Indoor photography, 20, 21, 26
- Interface, 52, 53, 56, 60, 76
- Internal memory, 12, 14

J

- JPEG, 89
- JPG, 89

L

- Landscapes, 26
- Language, 76
- Language, choosing, 76
- Lens, 2, 79
- List by date, 46

M

- Macro close-up, 23, 28
- Memory cards, 12–13, 76, 77, 88
 - approved, 77
 - capacity of, 88
 - formatting, 12, 76

inserting and removing, 12–13

Memory card slot, 3, 12–13

Menus, 5, 17, 61

Menus, 70

Monitor, 3, 6–7, 79

brightness, 73

indicators in, 6–7

Monitor settings, 73

MOV, 89

Movies, 35–37

recording, 35–37

viewing, 37

MOVIE menu, 36–37

Moving subjects, 34, 63

Multi selector, 4, 17

N

Night photography, 20, 26

Noise reduction, 21, 27–28, 34

NTSC, *see* Video mode

Number of exposures remaining,
14, 88

O

On/off, *see* Power switch

One-touch portrait, 24–25

button, 2

menu, 25

P

PAL, *see* Video mode

Panorama, 29–30

Photo info, *see* **Monitor settings**

PictBridge, 55–59, 86

Pictmotion, 48–51

PictureProject, 50, 52–54

PLAYBACK MENU, 67–69

Playback, 19, 41

calendar, 45, 47

full-frame, 19, 41

list by date, 46–47

menu, 67–69

movies, 37

on TV, 52

Pictmotion, 51

thumbnail, 41

voice memo, 44

zoom, 42

Portraits, 24–25, 26

Power-on lamp, 2, 14

Power switch, 2, 14

Printing pictures, 55–60. *See*

also Date and time, printing;

Date imprint; Digital Print Or-
der Format; PictBridge; **Print set**

Print set, 59

Print size, 57–58

Protect, 68

Protected pictures, 6–7, 68, 76

Q

Quick format, *see* **Format card**

Quick startup, 70

QuickTime, 91

R

Red-eye reduction, *see* Flash,
mode

Reset all, 76, 87

S

SCN (scene) mode, 26–31

Back light (🌙), 28

Beach/Snow (🏖️), 27

Close-up (👁️), 28

Copy (📄), 28

Dusk/Dawn (🌆), 28

Fireworks show (🎆), 28

Museum (🏛️), 28

Night landscape (🌃), 28

Panorama assist (📷), 29–30

Party/Indoor (🎉), 27

Sunset (🌇), 27

Scene assist modes, 32–34

Landscape (🏞️), 33

Night portrait (🌃), 34

Portrait (👤), 33

Sports (🏃), 34

Secure Digital (SD), *see* Memory
cards

Self-timer, 22

Self-timer lamp, 2, 22

Sepia, 66

SET UP MENU, 70–76

SHOOTING MENU, 61–66

Shutter-release button, 2, 16

Shutter sound, *see* **Sound settings**

Single AF, *see* Focus, mode

Size, *see* **Image mode**

Slide show, 68

Slow sync, *see* Flash, mode

Small pic., 69

Smear, 78

Sound, 37, 39, 44, 51, 75

Sound settings, 75

Standby mode, *see* Auto off

Strap, camera, 2–3

Support information, 1

T

Telephoto, *see* Zoom

Television, 36, 52, 61, 76

connecting to, 52

Thumbnail playback, 41

Time, *see* **Date**

Time zone, 71–72, 90

Timer, *see* Self-timer

Transfer, 52–54

mark, 53

marking pictures for, 53, 68, 76

Transfer marking, 68

Tripod, 3, 22, 27–28, 34

T button, *see* Zoom control

U

USB, 54, 76. *See also* **Interface**

USB, 52–54, 56, 60

cable, 8, 52–54, 56

connection, 52–54, 56

connector, 8, 52–54, 56

V

VCR, 52

Video mode, 52, 76. *See*

also **Interface**

Vivid color, 66

Voice memo, 44

Voice recording, 38–40

Volume, 37, 39, 44, 51, 75

Volume, *see* **Sound settings**

W

WAV, 89

White screen, 71

White balance, 62

White balance, 62

preset, 62

Wide angle, *see* Zoom

W button, *see* Zoom control

Z

Zoom, 15

digital, 15

indicator, 6–7, 15

optical, 15

playback, 42

Zoom control, 2

Nikon

No reproduction in any form of this manual, in whole or in part (except for brief quotation in critical articles or reviews), may be made without written authorization from NIKON CORPORATION.

NIKON CORPORATION

Fuji Bldg., 2-3 Marunouchi 3-chome,
Chiyoda-ku, Tokyo 100-8331, Japan

SB6A01(11)
6MA16311--